

distinte di taglio cutting sizes

atlantis
serie 55TT

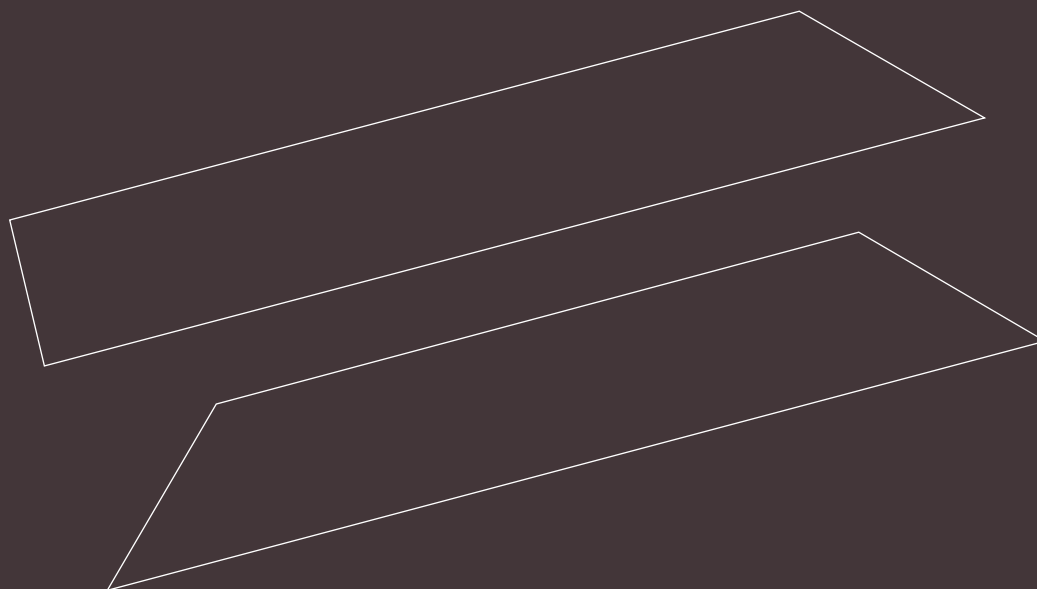

TO.MA. S.p.a.
ESTRUSIONE ALLUMINIO

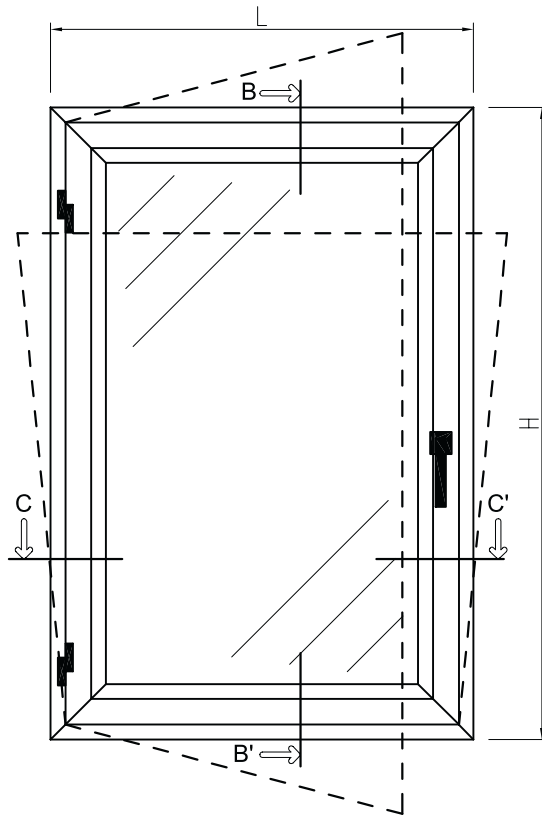

Sezione B-B'

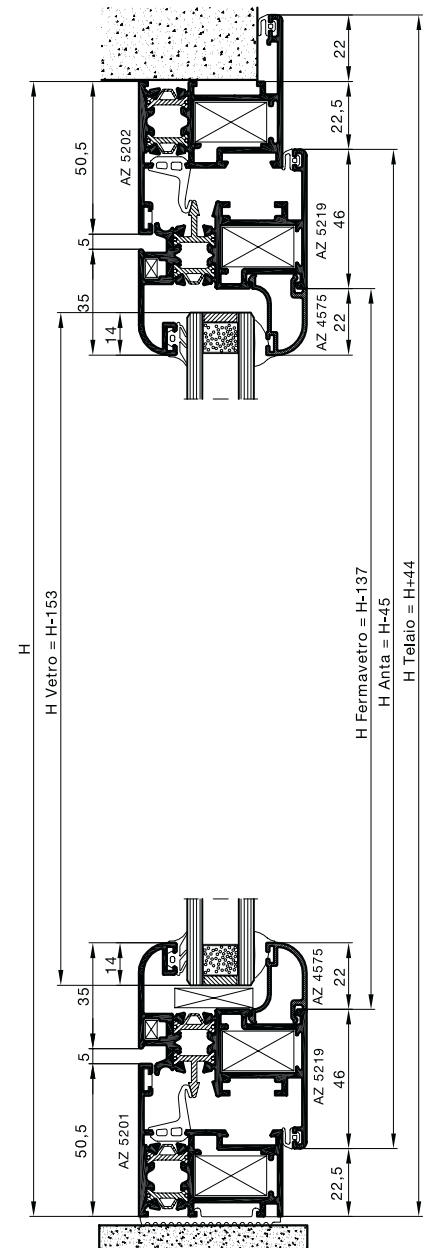





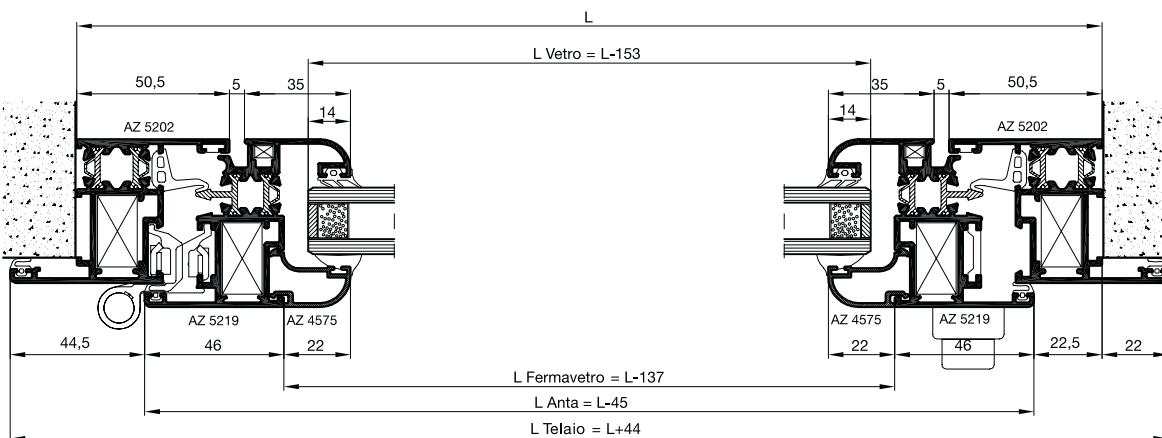

CALCOLO PESO PROFILI		TOTALE KG
Profili Orizz.	Kg/ml $5,6 \times L$	
Profili Vert.	Kg/ml $5,7 \times H$	
TOTALE		

DISTINTA TAGLIO VETRI			
Posizione	l	h	Q.tà
	L - 153	H - 153	1

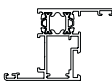
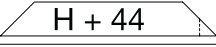
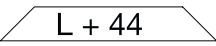

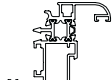
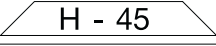
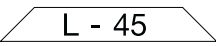
Sezione C-C'

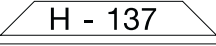
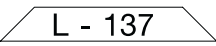
DISTINTA TAGLIO PROFILI

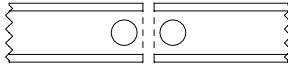
ARTICOLO	PROFILO	DESCRIZIONE	TAGLIO	Nr. Pezzi
AZ 5202		TELAIO Z	 H + 44	2
			 L + 44	1
AZ 5201		TELAIO L	 L	1
AZ 5219		ANTA	 H - 45	2
			 L - 45	2
AZ 4575		FERMAVETRO	 H - 137	2
			 L - 137	2
AZ 2035		ASTINA DI COMANDO		1

GUARNIZIONI

	ART.	DESCRIZIONE	N° P.zzi
	Rg 308	G. INTERNA VETRO	2L + 2H
	Rg 312	G. ESTERNA VETRO	2L + 2H
	Rg 330	G. CENTRALE DI TENUTA	2L + 2H
	Rg 402	G. BATTUTA INTERNA E A MURO	3L + 4H
	Ra 1703	ANGOLO VULCANIZZATO	4
	Rg 323	G. ISOLAMENTO SOGLIA	1L

ACCESSORI

ART.	DESCRIZIONE	N° P.zzi
Ra 1702	SQUADRETTA DI ALLINEAMENTO TELAI0	4
Ra 1705 Ra 1706	SQUADRETTA	8
Ra 1710	SQUADRETTA ANTA ESTERNA	4
Ra 1404	REGOLATORE A MURO	8
Ra 1033	CAPPETTA DI DRENAGGIO	2

ACCESSORI ANTA RIBALTA

ART.	DESCRIZIONE	N° P.zzi
Ra 1458	MECC. BASE AR FUTURA	1
Ra 1057	CREMONESE PRIMA AR	1
Ra 1459	BRACCIO TIPO 1	1

ACCESSORI ANTA BATTENTE

ART.	DESCRIZIONE	N° P.zzi
Ra 1427	CERNIERA FLASH BASE	2
Ra 1056	CREMONESE PRIMA	1
Ra 1447	BLOCCHETTO DI COLLEGAMENTO	1 CP.
Ra 1002	TERMINALE DI CHIUSURA	2
Ra 1437	INCONTRO IN ZAMA	2

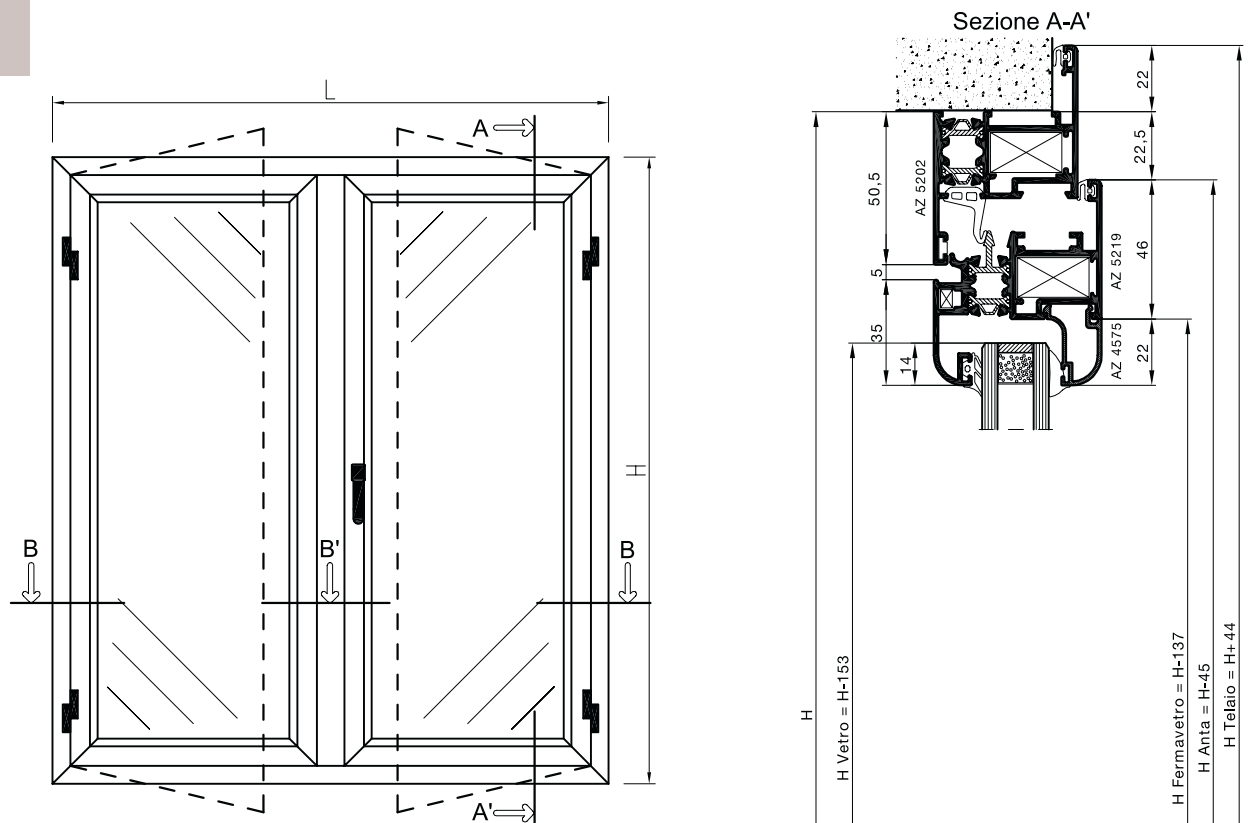





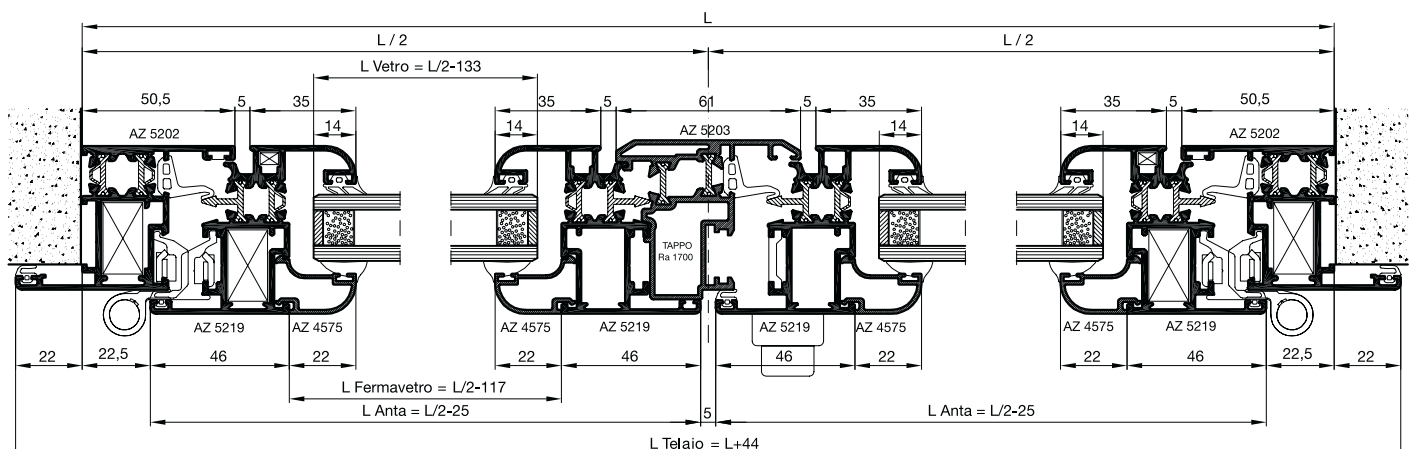

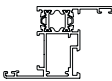

CALCOLO PESO PROFILI		TOTALE KG
Profili Orizz.	Kg/ml $5,6 \times L$	
Profili Vert.	Kg/ml $10,2 \times H$	
TOTALE		

DISTINTA TAGLIO VETRI			
Posizione	l	h	Q.tà
	L/2 - 133	H - 153	2

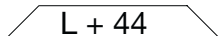
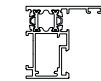

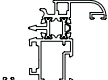
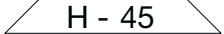
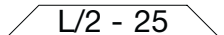
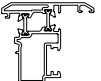
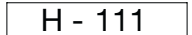
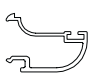
Sezione B-B'-B

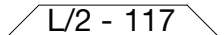
DISTINTA TAGLIO PROFILI

ARTICOLO	PROFILO	DESCRIZIONE	TAGLIO	Nr. Pezzi
AZ 5202		TELAIO Z	 H + 44	2
			 L + 44	1
AZ 5201		TELAIO L	 L	1
AZ 5219		ANTA	 H - 45	2
			 L/2 - 25	2
AZ 5203		RIPORTO CENTRALE	 H - 111	1
AZ 4575		FERMAVETRO	 H - 137	2
			 L/2 - 117	2
AZ 2035		ASTINA DI COMANDO		1

GUARNIZIONI

	ART.	DESCRIZIONE	N° P.zzi
	Rg 308	G. INTERNA VETRO	2L + 4H
	Rg 312	G. ESTERNA VETRO	2L + 4H
	Rg 330	G. CENTRALE DI TENUTA	2L + 3H
	Rg 402	G. BATTUTA INTERNA E A MURO	3L + 5H
	Ra 1703	ANGOLO VULCANIZZATO	4
	Rg 323	G. ISOLAMENTO SOGLIA	1L

ACCESSORI

ART.	DESCRIZIONE	N° P.zzi
Ra 1702	SQUADRETTA DI ALLINEAMENTO TELAIO	4
Ra 1705 Ra 1706	SQUADRETTA	12
Ra 1710	SQUADRETTA ANTA ESTERNA	8
Ra 1404	REGOLATORE A MURO	10
Ra 1033	CAPPETTA DI DRENAGGIO	3

ACCESSORI ANTA BATTENTE

ART.	DESCRIZIONE	N° P.zzi
Ra 1427	CERNIERA FLASH BASE	4
Ra 1056	CREMONESE PRIMA	1
Ra 1447	BLOCCHETTO DI COLLEGAMENTO	1 CP.
Ra 1002	TERMINALE DI CHIUSURA	2
Ra 2808	INCONTRO DOPPIO IN ZAMA	2
Ra 1035	CATENACCI GIAP IN NYLON	2
Ra 1700	TAPPO PER RIPORTO CENT.	1 CP.

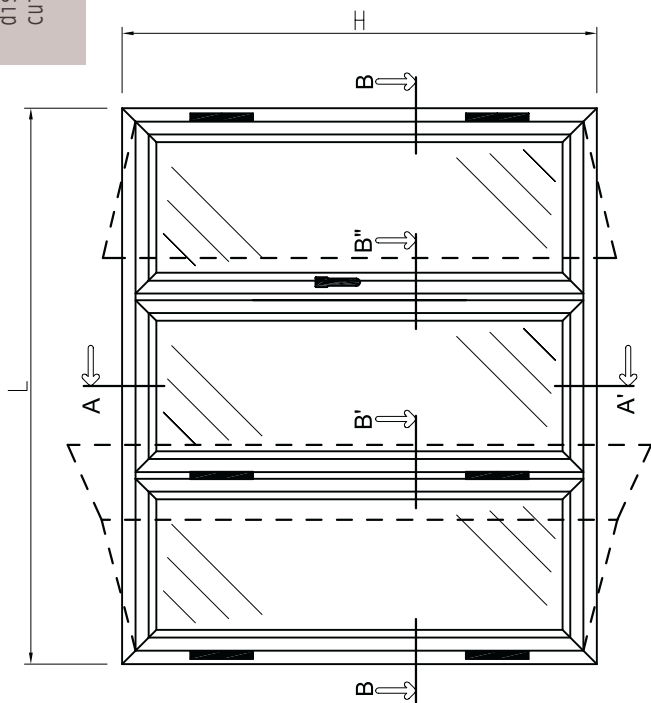

CALCOLO PESO PROFILI		TOTALE
Profili Orizz.	Kg/ml	5,6 x L
Profili Vert.	Kg/ml	14,8 x H
		TOTALE

DISTINTA TAGLIO VETRI			
Posizione	l	h	Q.tà
	L/3 - 126,3	H - 153	3

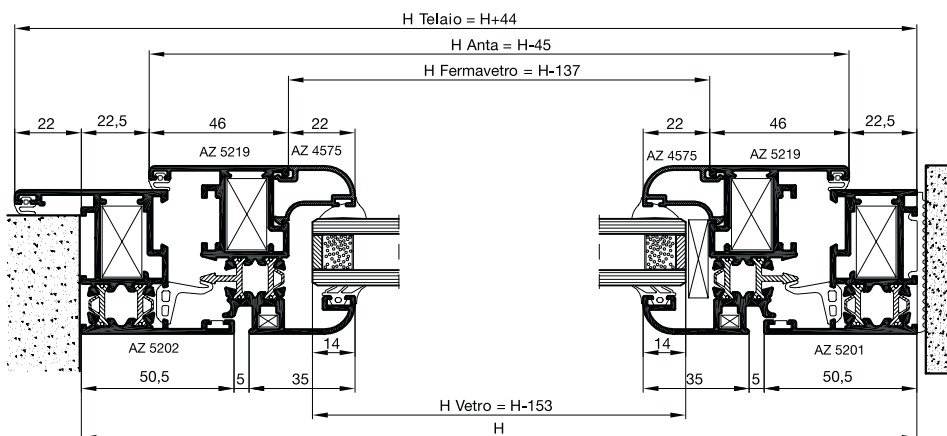





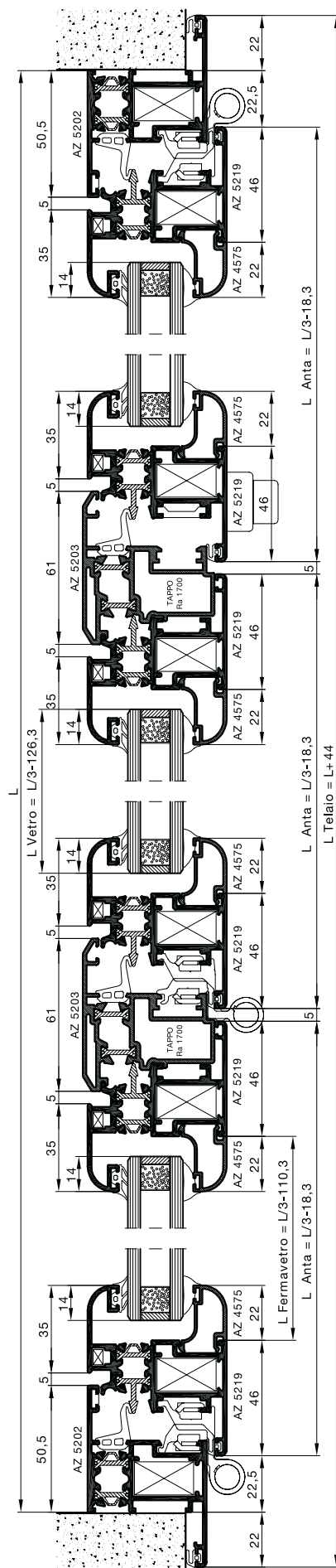

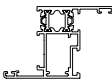

Sezione A-A'

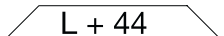
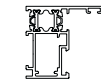
Sezione B-B'-B''-B

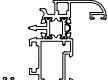
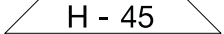
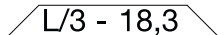
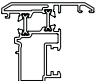
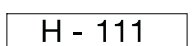
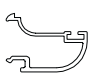

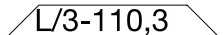
DISTINTA TAGLIO PROFILI

ARTICOLO	PROFILO	DESCRIZIONE	TAGLIO	Nr. Pezzi
AZ 5202		TELAIO Z	 H + 44	2
			 L + 44	1
AZ 5201		TELAIO L	 L	1
AZ 5219		ANTA	 H - 45	2
			 L/3 - 18,3	2
AZ 5203		RIPORTO CENTRALE	 H - 111	2
AZ 4575		FERMAVETRO	 H - 137	2
			 L/3-110,3	2
AZ 2035		ASTINA DI COMANDO		1

GUARNIZIONI

	ART.	DESCRIZIONE	N° P.zzi
	Rg 308	G. INTERNA VETRO	2L + 6H
	Rg 312	G. ESTERNA VETRO	2L + 6H
	Rg 330	G. CENTRALE DI TENUTA	2L + 4H
	Rg 402	G. BATTUTA INTERNA E A MURO	3L + 6H
	Ra 1703	ANGOLO VULCANIZZATO	4
	Rg 323	G. ISOLAMENTO SOGLIA	1L

ACCESSORI

ART.	DESCRIZIONE	N° P.zzi
Ra 1702	SQUADRETTA DI ALLINEAMENTO TELAIO	4
Ra 1705 Ra 1706	SQUADRETTA	16
Ra 1710	SQUADRETTA ANTA ESTERNA	12
Ra 1404	REGOLATORE A MURO	12
Ra 1033	CAPPETTA DI DRENAGGIO	4

ACCESSORI ANTA BATTENTE

ART.	DESCRIZIONE	N° P.zzi
Ra 1427	CERNIERA FLASH BASE	4
Ra 1428	CERNIERA FLASH 3ANTA	2
Ra 1056	CREMONESE PRIMA	1
Ra 1447	BLOCCHETTO DI COLLEGAMENTO	1 CP.
Ra 1002	TERMINALE DI CHIUSURA	2
Ra 2808	INCONTRO DOPPIO IN ZAMA	2
Ra 1035	CATENACCI GIAP IN NYLON	4
Ra 1700	TAPPO PER RIPORTO CENT.	2 CP.
Ra 1437	INCONTRO SINGOLO IN ZAMA	2

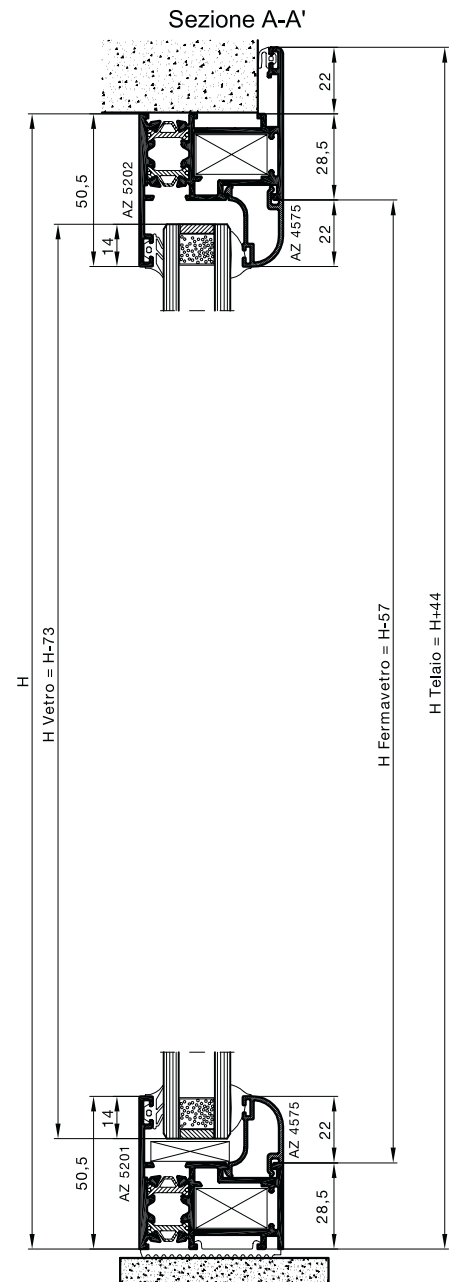
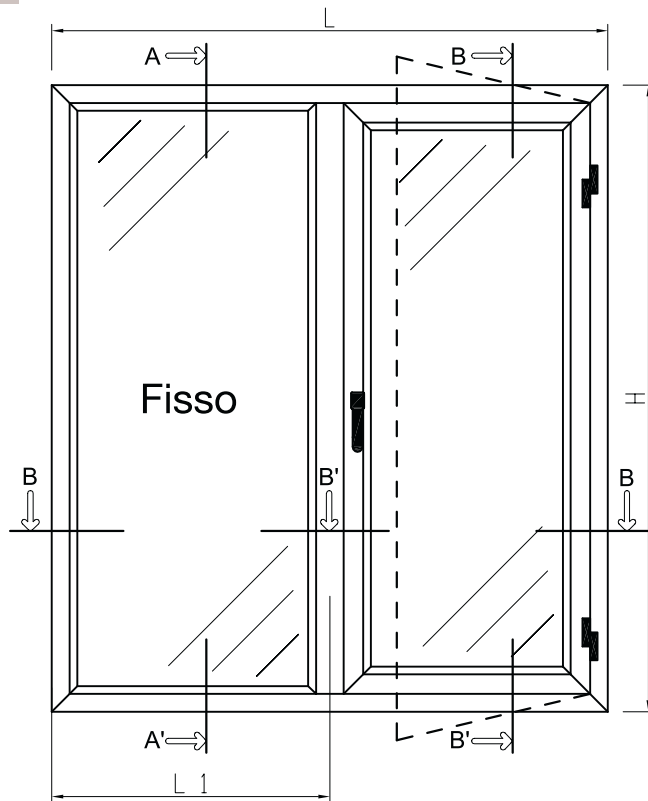

CALCOLO PESO PROFILI		TOTALE KG
Profili Orizz.	Kg/ml $4,2 \times L$	
Profili Vert.	Kg/ml $7,5 \times H$	
TOTALE		

DISTINTA TAGLIO VETRI			
Posizione	l	h	Q.tà
	L-L1-138,3	H - 153	1
Fisso	L-L1 - 58,3	H - 73	1

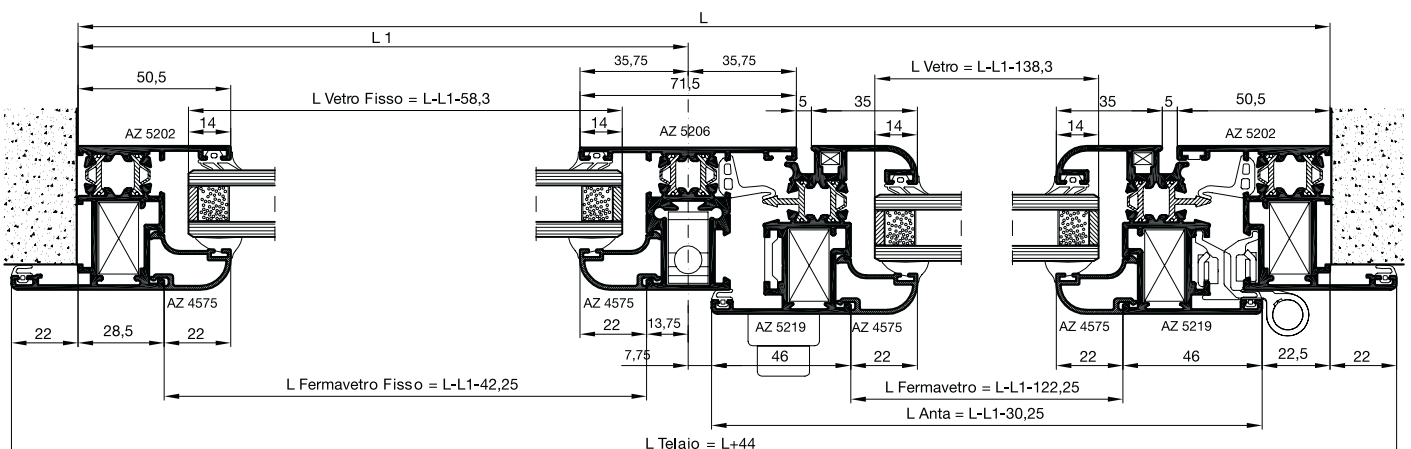

DISTINTA TAGLIO PROFILI

ARTICOLO	PROFILO	DESCRIZIONE	TAGLIO	Nr. Pezzi
AZ 5202		TELAIO Z	 H + 44	2
			 L + 44	1
AZ 5201		TELAIO L	 L	1
AZ 5219		ANTA	 H - 45	2
			 L-L1-30,25	2
AZ 5206		TRAVERSO	 H - 101	1
AZ 4575		FERMAVETRO	 H - 137	2
			 L-L1-122,25	2
AZ 4575		FERMAVETRO PARTE FISSA	 H - 73	2
			 L-L1-42,25	2
AZ 2035		ASTINA DI COMANDO		1

GUARNIZIONI

	ART.	DESCRIZIONE	N° P.zzi
	Rg 308	G. INTERNA VETRO	2L + 4H
	Rg 312	G. ESTERNA VETRO	2L + 4H
	Rg 330	G. CENTRALE DI TENUTA	2L/2 + 2H
	Rg 402	G. BATTUTA INTERNA E A MURO	3L + 4H
	Ra 1703	ANGOLO VULCANIZZATO	4
	Rg 323	G. ISOLAMENTO SOGLIA	1L

ACCESSORI

ART.	DESCRIZIONE	N° P.zzi
Ra 1702	SQUADRETTA DI ALLINEAMENTO TELAIO	4
Ra 1705 Ra 1706	SQUADRETTA	8
Ra 1710	SQUADRETTA ANTA ESTERNA	4
Ra 1404	REGOLATORE A MURO	8
Ra 1033	CAPPETTA DI DRENAGGIO	2
Ra 1420	CAVALLOTTO	2

ACCESSORI ANTA BATTENTE

ART.	DESCRIZIONE	N° P.zzi
Ra 1427	CERNIERA FLASH BASE	2
Ra 1056	CREMONESE PRIMA	1
Ra 1447	BLOCCHETTO DI COLLEGAMENTO	1 CP.
Ra 1002	TERMINALE DI CHIUSURA	2
Ra 1437	INCONTRO IN ZAMA	2

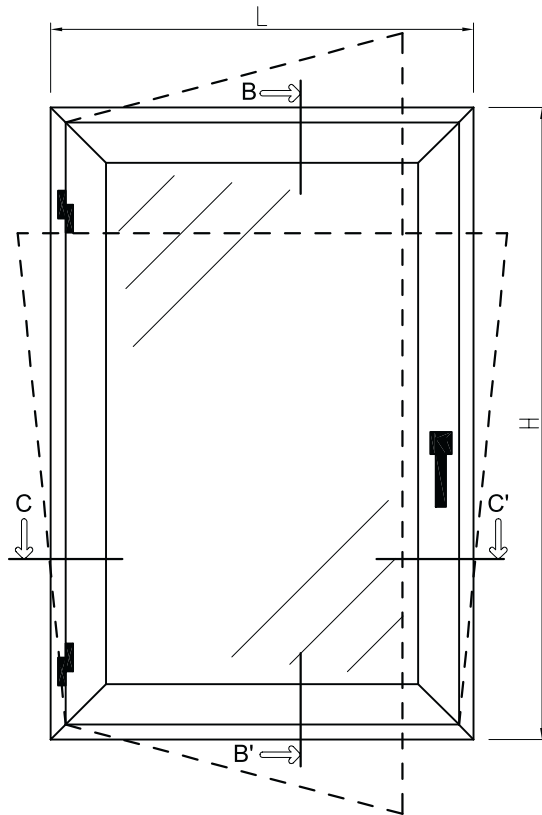

Sezione B-B'

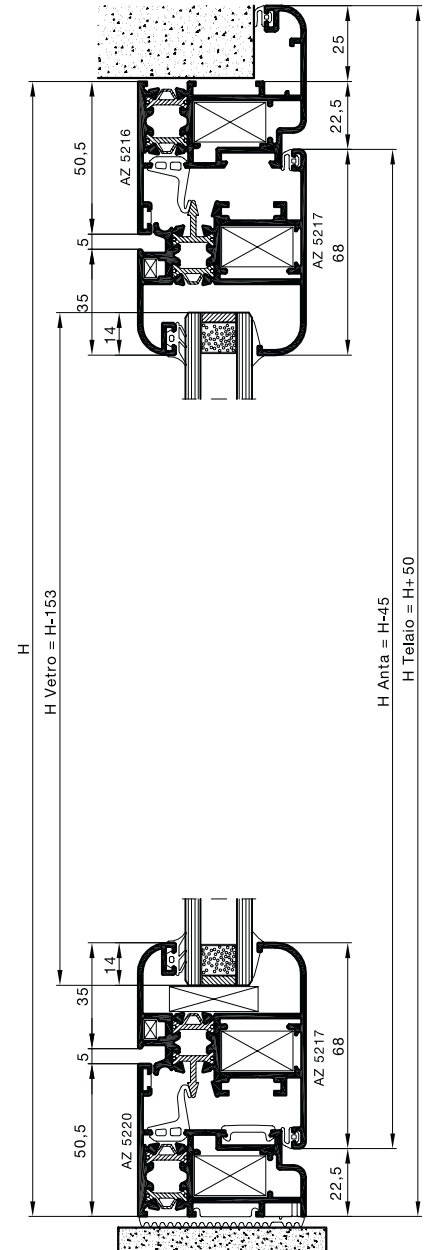



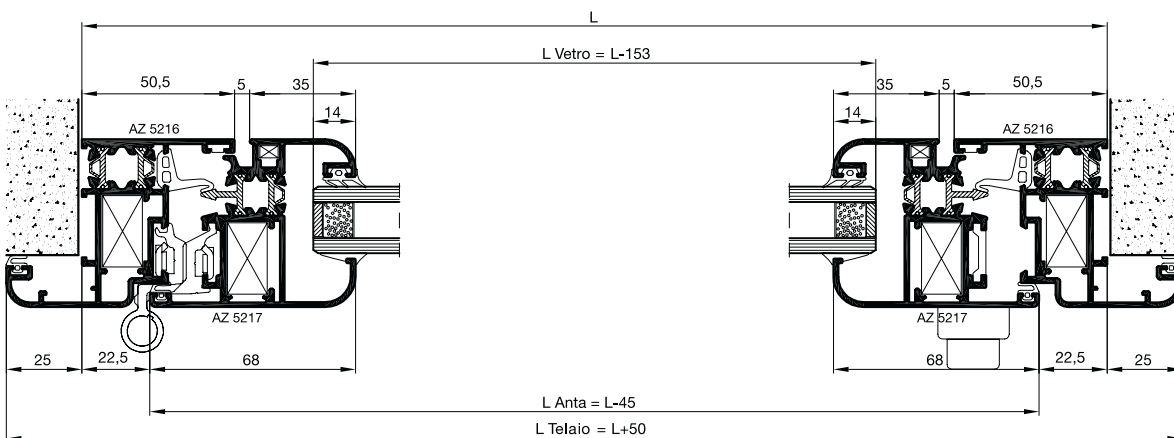

CALCOLO PESO PROFILI		TOTALE KG
Profili Orizz.	Kg/ml $5,5 \times L$	
Profili Vert.	Kg/ml $5,8 \times H$	
TOTALE		

DISTINTA TAGLIO VETRI			
Posizione	l	h	Q.tà
	L - 153	H - 153	1

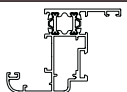
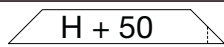
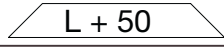

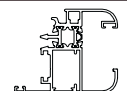
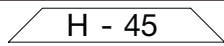
Sezione C-C'

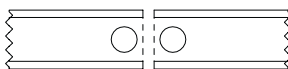
DISTINTA TAGLIO PROFILI				
ARTICOLO	PROFILO	DESCRIZIONE	TAGLIO	Nr. Pezzi
AZ 5216		TELAIO Z	 H + 50	2
			 L + 50	1
AZ 5220		TELAIO L	 L	1
AZ 5217		ANTA	 H - 45	2
			 L - 45	2
AZ 2035		ASTINA DI COMANDO		1

GUARNIZIONI			
	ART.	DESCRIZIONE	N° P.zzi
	Rg 307	G. INTERNA VETRO	2L + 2H
	Rg 312	G. ESTERNA VETRO	2L + 2H
	Rg 330	G. CENTRALE DI TENUTA	2L + 2H
	Rg 402	G. BATTUTA INTERNA E A MURO	3L + 4H
	Ra 1703	ANGOLO VULCANIZZATO	4
	Rg 323	G. ISOLAMENTO SOGLIA	1L

ACCESSORI		
ART.	DESCRIZIONE	N° P.zzi
Ra 1702	SQUADRETTA DI ALLINEAMENTO TELAIO	4
Ra 1705 Ra 1706	SQUADRETTA	8
Ra 1710	SQUADRETTA ANTA ESTERNA	4
Ra 1404	REGOLATORE A MURO	8
Ra 1033	CAPPETTA DI DRENAGGIO	2

ACCESSORI ANTA RIBALTA		
ART.	DESCRIZIONE	N° P.zzi
Ra 1455	MECC. AR FUTURA SOL. COMPL.	1
Ra 1057	CREMONESE PRIMA AR	1
Ra 1044	BRACCIO TIPO 1	1

ACCESSORI ANTA BATTENTE		
ART.	DESCRIZIONE	N° P.zzi
Ra 1428	CERNIERA FLASH SOL. COMPL.	2
Ra 1056	CREMONESE PRIMA	1
Ra 1447	BLOCCHETTO DI COLLEGAMENTO	1 CP.
Ra 1002	TERMINALE DI CHIUSURA	2
Ra 1437	INCONTRO IN ZAMA	2

Sezione A-A'

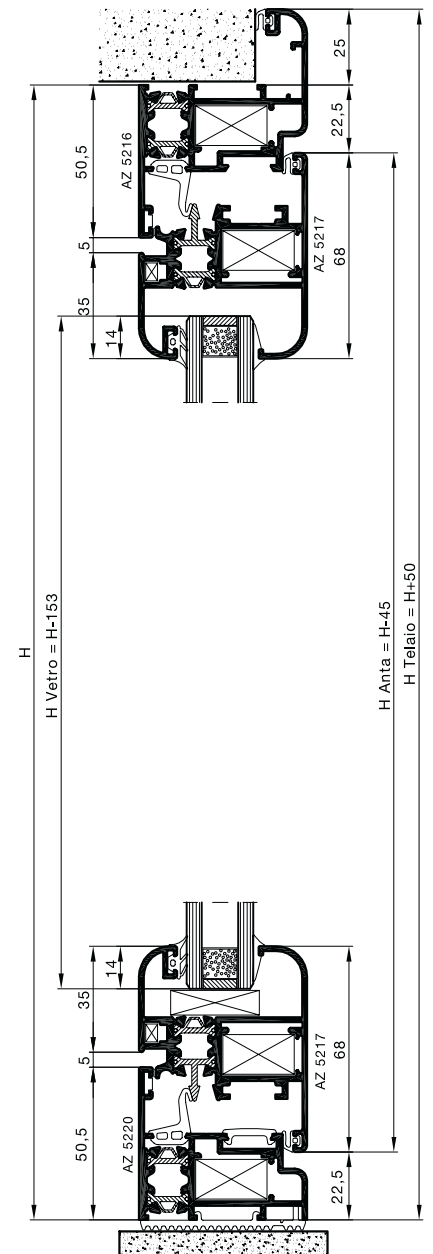
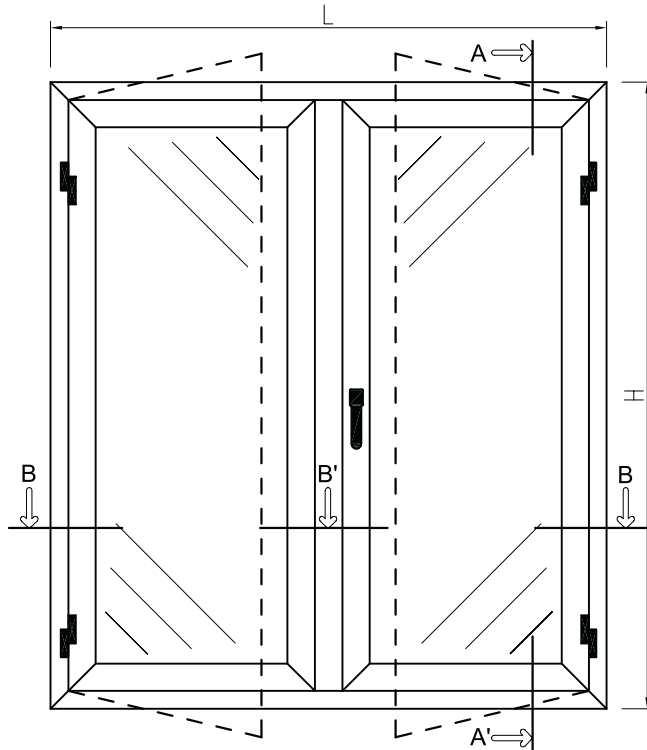



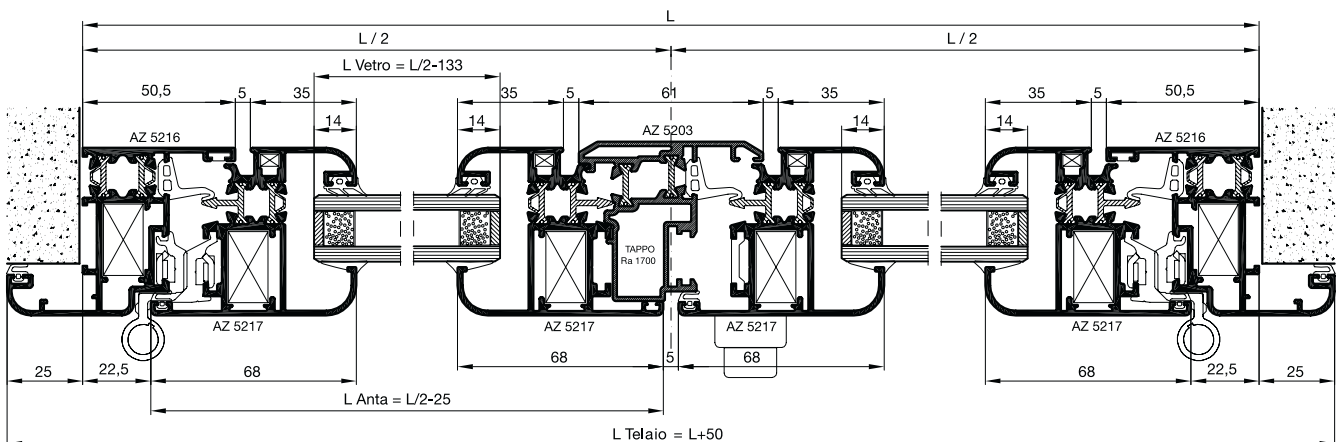

CALCOLO PESO PROFILI		TOTALE KG
Profili Orizz.	Kg/ml <u>5,5</u> x L	
Profili Vert.	Kg/ml <u>10,1</u> x H	
TOTALE		

DISTINTA TAGLIO VETRI			
Posizione	l	h	Q.tà
	L/2 - 133	H - 153	2

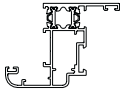
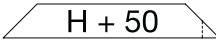
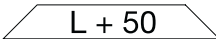
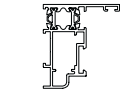

Sezione B-B'-B

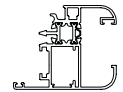
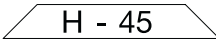
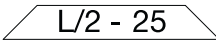
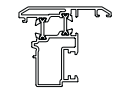
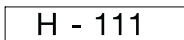
DISTINTA TAGLIO PROFILI

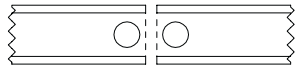
ARTICOLO	PROFILO	DESCRIZIONE	TAGLIO	Nr. Pezzi
AZ 5216		TELAIO Z	 H + 50	2
			 L + 50	1
AZ 5220		TELAIO L	 L	1
AZ 5217		ANTA	 H - 45	2
			 L/2 - 25	2
AZ 5203		RIPORTO CENTRALE	 H - 111	1
AZ 2035		ASTINA DI COMANDO		1

GUARNIZIONI

	ART.	DESCRIZIONE	N° P.zzi
	Rg 307	G. INTERNA VETRO	2L + 4H
	Rg 312	G. ESTERNA VETRO	2L + 4H
	Rg 330	G. CENTRALE DI TENUTA	2L + 3H
	Rg 402	G. BATTUTA INTERNA E A MURO	3L + 5H
	Ra 1703	ANGOLO VULCANIZZATO	4
	Rg 323	G. ISOLAMENTO SOGLIA	1L

ACCESSORI

ART.	DESCRIZIONE	N° P.zzi
Ra 1702	SQUADRETTA DI ALLINEAMENTO TELAIO	4
Ra 1705 Ra 1706	SQUADRETTA	12
Ra 1710	SQUADRETTA ANTA ESTERNA	8
Ra 1404	REGOLATORE A MURO	10
Ra 1033	CAPPETTA DI DRENAGGIO	3

ACCESSORI ANTA BATTENTE

ART.	DESCRIZIONE	N° P.zzi
Ra 1428	CERNIERA FLASH SOL. COMPL.	4
Ra 1056	CREMONESE PRIMA	1
Ra 1447	BLOCCHETTO DI COLLEGAMENTO	1 CP.
Ra 1002	TERMINALE DI CHIUSURA	2
Ra 2808	INCONTRO DOPPIO IN ZAMA	2
Ra 1035	CATENACCI GIAP IN NYLON	2
Ra 1700	TAPPO PER RIPORTO CENT.	1 CP.

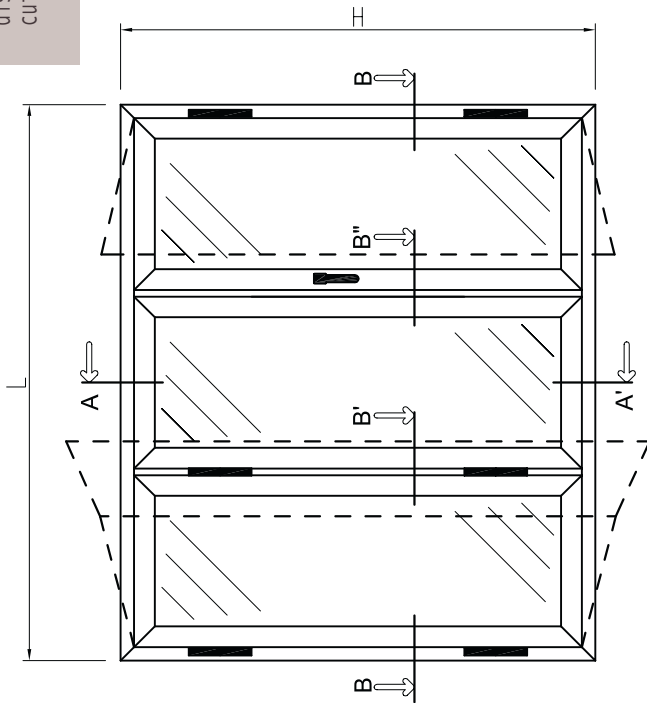

CALCOLO PESO PROFILI		TOTALE KG
Profili Orizz.	Kg/ml 5,5 x L	
Profili Vert.	Kg/ml 14,4 x H	
TOTALE		

DISTINTA TAGLIO VETRI			
Posizione	l	h	Q.tà
	L/3 - 126,3	H - 153	3

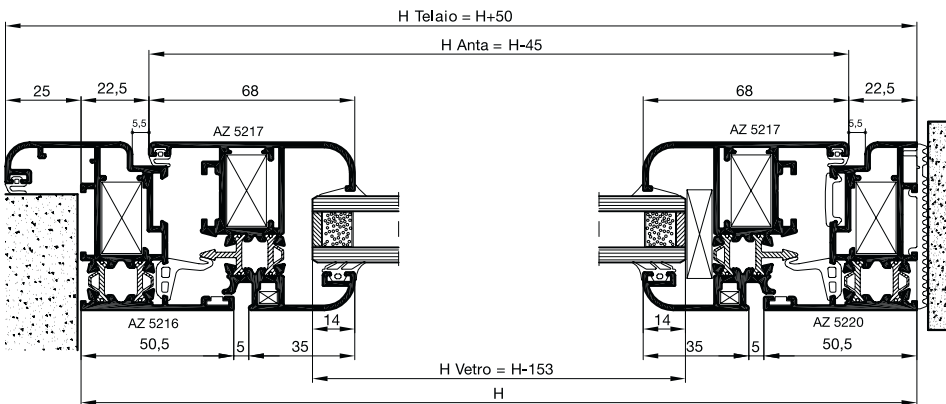

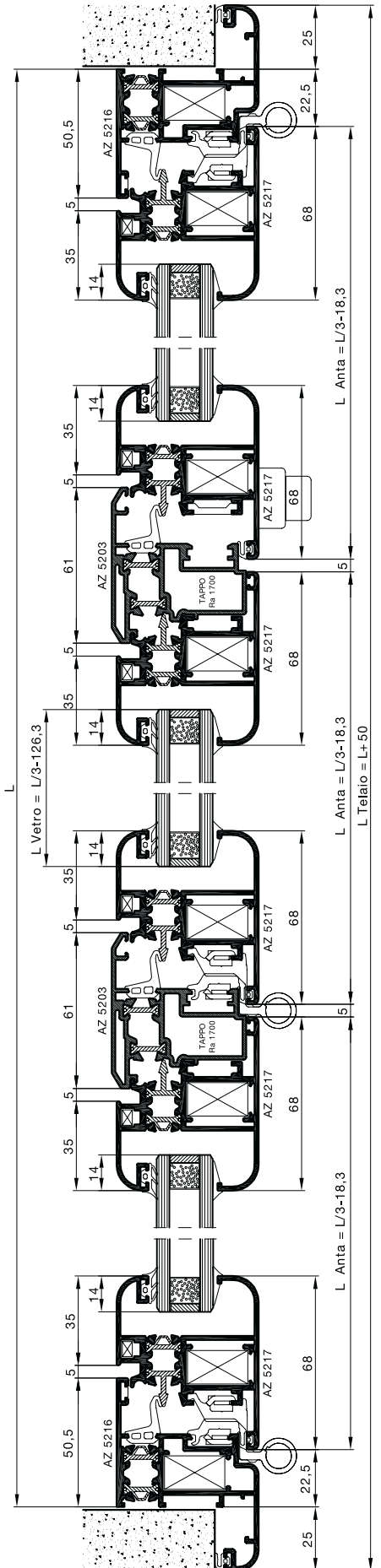

Sezione A-A'

Sezione B-B'-B''-B

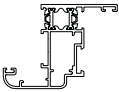
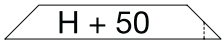
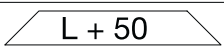
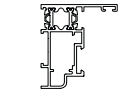
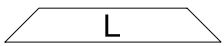
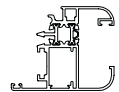
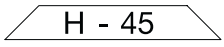
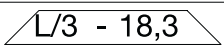
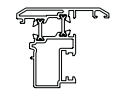
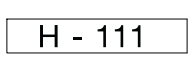

DISTINTA TAGLIO PROFILI

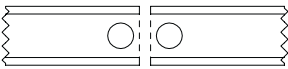
ARTICOLO	PROFILO	DESCRIZIONE	TAGLIO	Nr. Pezzi
AZ 5216		TELAIO Z		2
				1
AZ 5220		TELAIO L		1
AZ 5217		ANTA		2
				2
AZ 5203		RIPORTO CENTRALE		2
AZ 2035		ASTINA DI COMANDO		1

GUARNIZIONI

	ART.	DESCRIZIONE	N° P.zzi
	Rg 307	G. INTERNA VETRO	2L + 6H
	Rg 312	G. ESTERNA VETRO	2L + 6H
	Rg 330	G. CENTRALE DI TENUTA	2L + 4H
	Rg 402	G. BATTUTA INTERNA E A MURO	3L + 6H
	Ra 1703	ANGOLO VULCANIZZATO	4
	Rg 323	G. ISOLAMENTO SOGLIA	1L

ACCESSORI

ART.	DESCRIZIONE	N° P.zzi
Ra 1702	SQUADRETTA DI ALLINEAMENTO TELAIO	4
Ra 1705 Ra 1706	SQUADRETTA	16
Ra 1710	SQUADRETTA ANTA ESTERNA	12
Ra 1404	REGOLATORE A MURO	12
Ra 1033	CAPPETTA DI DRENAGGIO	4

ACCESSORI ANTA BATTENTE

ART.	DESCRIZIONE	N° P.zzi
Ra 1427	CERNIERA FLASH BASE	4
Ra 1428	CERNIERA FLASH 3ANTA	2
Ra 1056	CREMONESE PRIMA	1
Ra 1447	BLOCCHETTO DI COLLEGAMENTO	1 CP.
Ra 1002	TERMINALE DI CHIUSURA	2
Ra 2808	INCONTRO DOPPIO IN ZAMA	2
Ra 1035	CATENACCI GIAP IN NYLON	4
Ra 1700	TAPPO PER RIPORTO CENT.	2 CP.
Ra 1437	INCONTRO SINGOLO IN ZAMA	2

Sezione B-B'

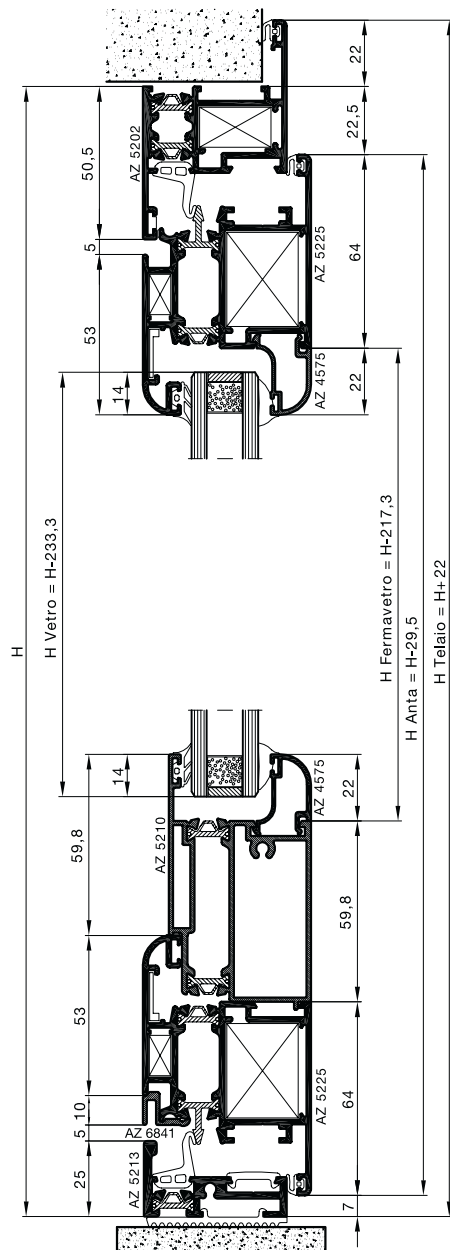
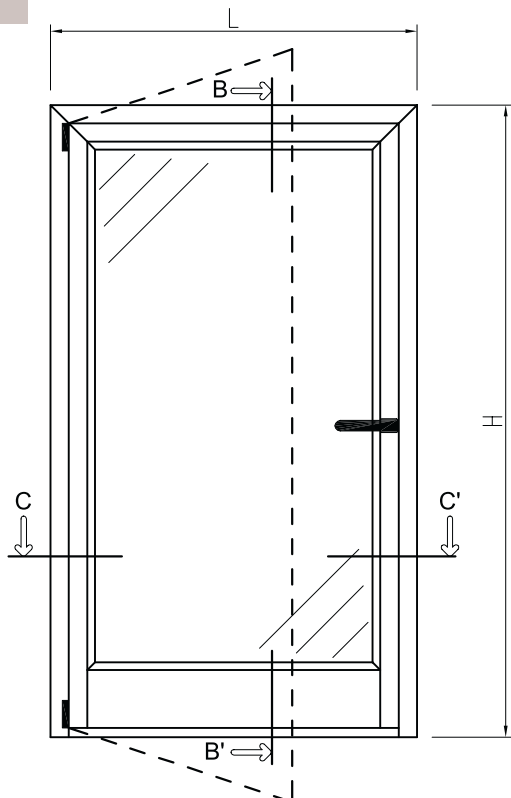





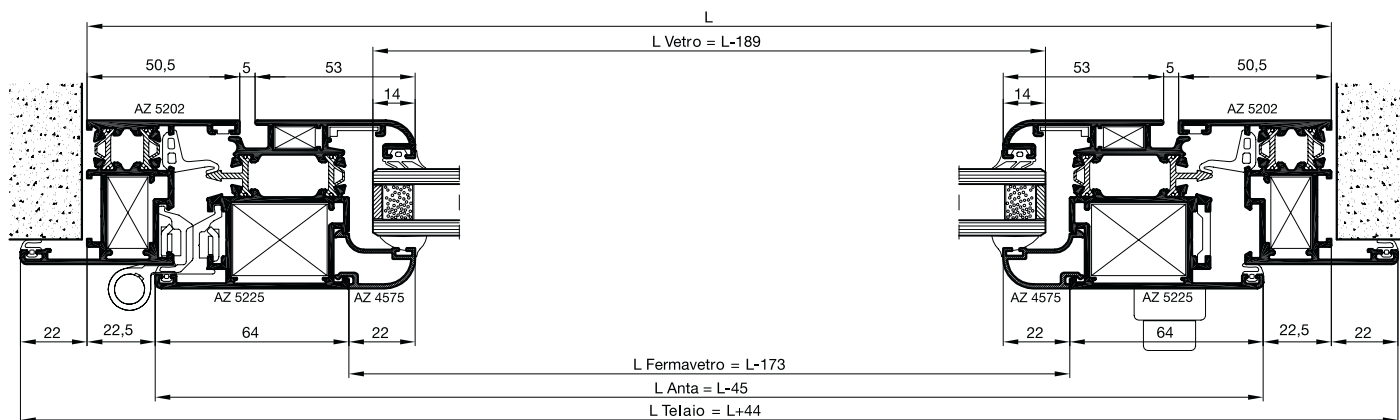

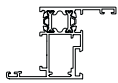
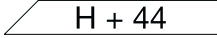
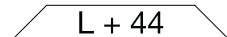

CALCOLO PESO PROFILI		TOTALE KG
Profili Orizz.	Kg/ml <u>7,5</u> x L	
Profili Vert.	Kg/ml <u>6,3</u> x H	
TOTALE		

DISTINTA TAGLIO VETRI			
Posizione	l	h	Q.tà
	L - 189	H - 233,3	1

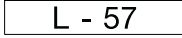
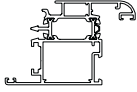
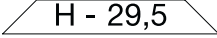
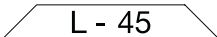

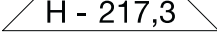
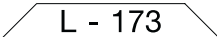
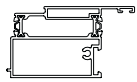
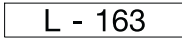
Sezione C-C'

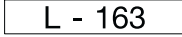
DISTINTA TAGLIO PROFILI

ARTICOLO	PROFILO	DESCRIZIONE	TAGLIO	Nr. Pezzi
AZ 5202		TELAIO Z	 H + 44	2
			 L + 44	1
AZ 5213		TELAIO L	 L - 57	1
AZ 5225		ANTA	 H - 29,5	2
			 L - 45	2
AZ 4575		FERMAVETRO	 H - 217,3	2
			 L - 173	2
AZ 5203		FINTO ZOCCOLO	 L - 163	1
AZ 6841		COPRI FUGA	 L - 163	1
AZ 2035		ASTINA DI COMANDO		1

GUARNIZIONI

	ART.	DESCRIZIONE	N° P.zzi
	Rg 308	G. INTERNA VETRO	2L + 2H
	Rg 312	G. ESTERNA VETRO	2L + 2H
	Rg 330	G. CENTRALE DI TENUTA	2L + 2H
	Rg 402	G. BATTUTA INTERNA E A MURO	3L + 4H
	Ra 1703	ANGOLO VULCANIZZATO	4
	Rg 323	G. ISOLAMENTO SOGLIA	1L

ACCESSORI

ART.	DESCRIZIONE	N° P.zzi
Ra 1702	SQUADRETTA DI ALLINEAMENTO TELAIIO	2
Ra 1704	SQUADRETTA DI ALLINEAMENTO ANTA	4
Ra 1705 Ra 1706	SQUADRETTA TELAIIO INTERNA	2
Ra 1707 Ra 1708	SQUADRETTA ANTA INTERNA	4
Ra 1712	SQUADRETTA ANTA ESTERNA	4
Ra 1404	REGOLATORE A MURO	8
Ra 1033	CAPPETTA DI DRENAGGIO	2

ACCESSORI ANTA RIBALTA

ART.	DESCRIZIONE	N° P.zzi
Ra 1458	MECC. BASE AR FUTURA	1
Ra 1057	CREMONESE PRIMA AR	1
Ra 1459	BRACCIO TIPO 1	1

ACCESSORI ANTA BATTENTE

ART.	DESCRIZIONE	N° P.zzi
Ra 1427	CERNIERA FLASH BASE	2
Ra 1056	CREMONESE PRIMA	1
Ra 1447	BLOCCHETTO DI COLLEGAMENTO	1 CP.
Ra 1002	TERMINALE DI CHIUSURA	2
Ra 1437	INCONTRO IN ZAMA	2

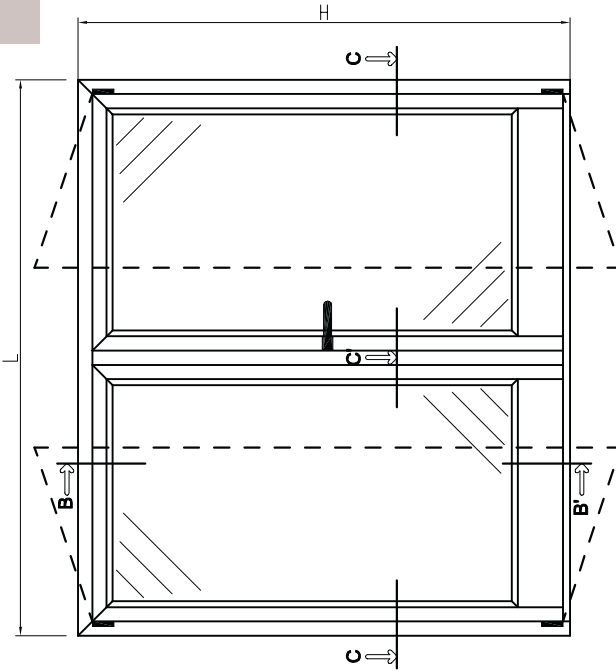

CALCOLO PESO PROFILI		TOTALE
Profili Orizz.	Kg/ml 7,5 x L	KG
Profili Vert.	Kg/ml 11,5 x H	
TOTALE		

DISTINTA TAGLIO VETRI			
Posizione	l	h	Q.tà
	L/2 - 169	H - 233,3	3

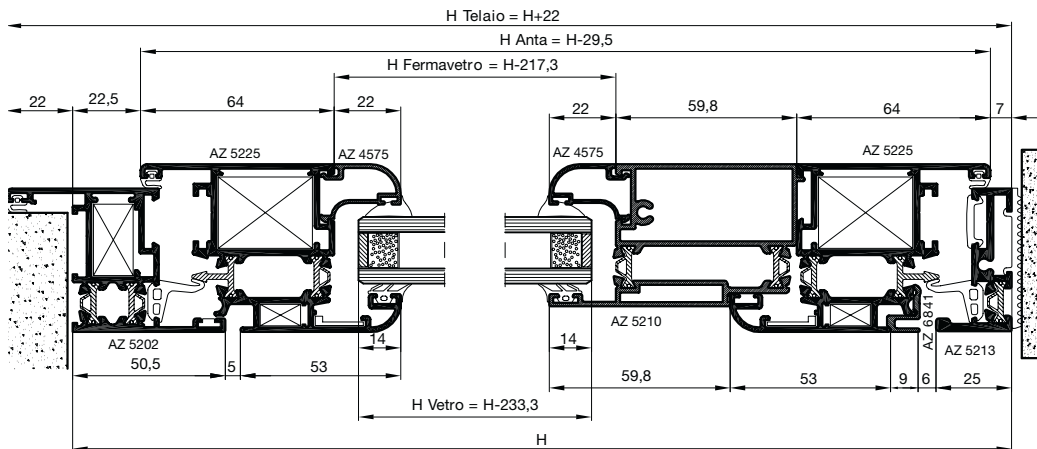





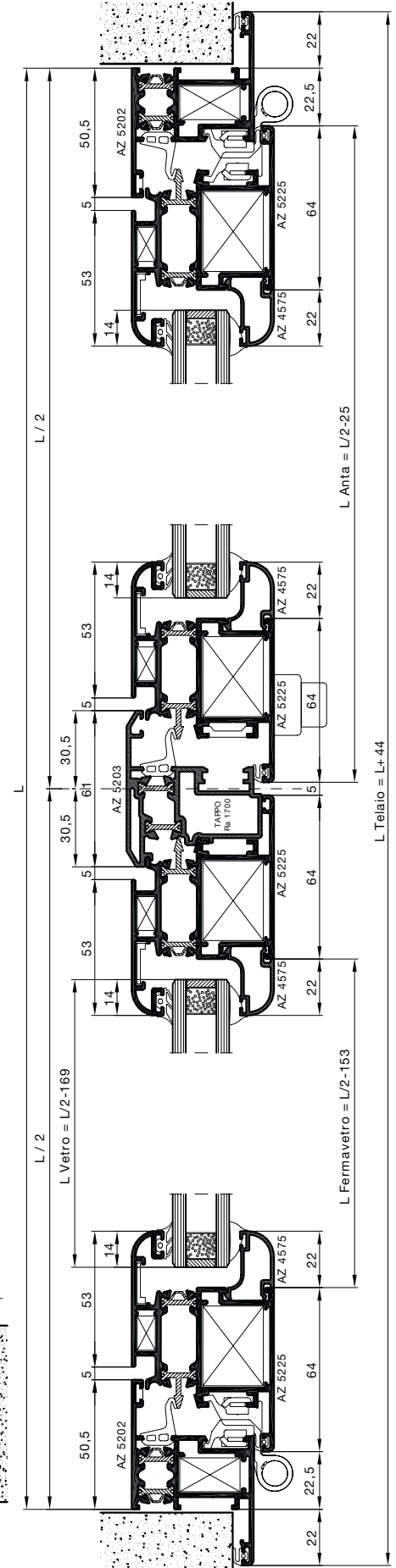

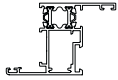
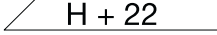
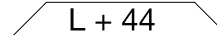

Sezione B-B'

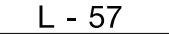
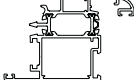
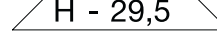
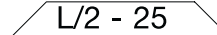
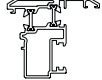
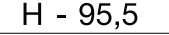
Sezione C-C'-C

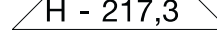
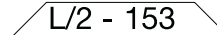
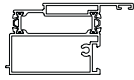
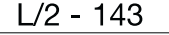

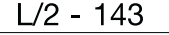
DISTINTA TAGLIO PROFILI

ARTICOLO	PROFILO	DESCRIZIONE	TAGLIO	Nr. Pezzi
AZ 5202		TELAIO Z	 H + 22	2
			 L + 44	1
AZ 5213		TELAIO L	 L - 57	1
AZ 5225		ANTA	 H - 29,5	4
			 L/2 - 25	2
AZ 5203		RIPORTO CENTRALE	 H - 95,5	1
AZ 4575		FERMAVETRO	 H - 217,3	4
			 L/2 - 153	4
AZ 5203		FINTO ZOCCOLO	 L/2 - 143	2
AZ 6841		COPRI FUGA	 L/2 - 143	2
AZ 2035		ASTINA DI COMANDO		1

GUARNIZIONI

	ART.	DESCRIZIONE	N° P.zzi
	Rg 308	G. INTERNA VETRO	2L + 4H
	Rg 312	G. ESTERNA VETRO	2L + 4H
	Rg 330	G. CENTRALE DI TENUTA	2L + 3H
	Rg 402	G. BATTUTA INTERNA E A MURO	3L + 5H
	Ra 1703	ANGOLO VULCANIZZATO	4
	Rg 323	G. ISOLAMENTO SOGLIA	1L

ACCESSORI

ART.	DESCRIZIONE	N° P.zzi
Ra 1702	SQUADRETTA DI ALLINEAMENTO TELAI0	2
Ra 1704	SQUADRETTA DI ALLINEAMENTO ANTA	8
Ra 1705 Ra 1706	SQUADRETTA TELAI0 INTERNA	2
Ra 1707 Ra 1708	SQUADRETTA ANTA INTERNA	8
Ra 1712	SQUADRETTA ANTA ESTERNA	8
Ra 1404	REGOLATORE A MURO	10
Ra 1033	CAPPETTA DI DRENAGGIO	3

ACCESSORI ANTA BATTENTE

ART.	DESCRIZIONE	N° P.zzi
Ra 1427	CERNIERA FLASH BASE	4
Ra 1056	CREMONESE PRIMA	1
Ra 1447	BLOCCHETTO DI COLLEGAMENTO	1 CP.
Ra 1002	TERMINALE DI CHIUSURA	2
Ra 2808	INCONTRO DOPPIO IN ZAMA	2
Ra 1035	CATENACCI GIAP IN NYLON	2
Ra 1700	TAPPO PER RIPORTO CENT.	1 CP.

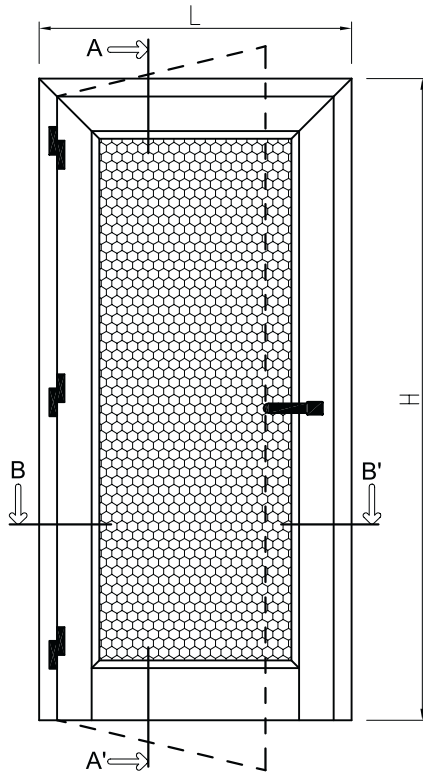

Sezione A-A'

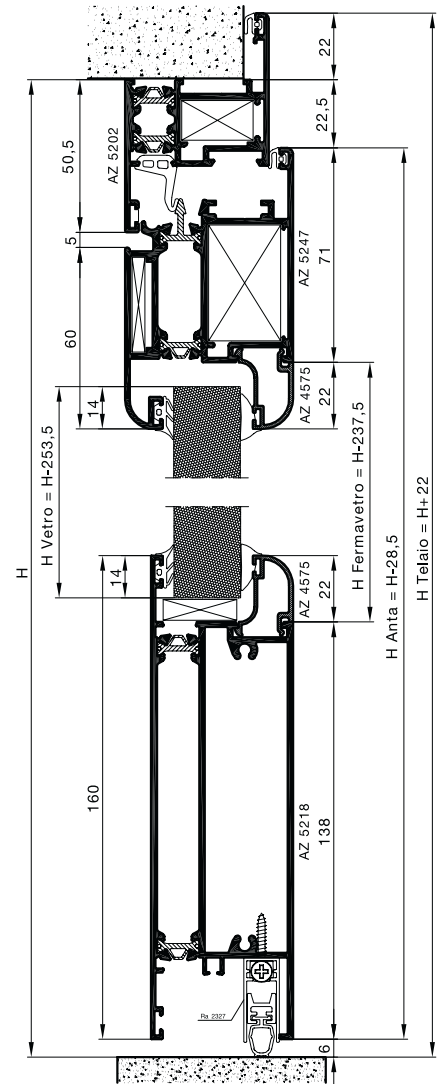

CALCOLO PESO PROFILI		TOTALE KG
Profili Orizz.	Kg/ml $6 \times L$	
Profili Vert.	Kg/ml $6,7 \times H$	
TOTALE		

DISTINTA TAGLIO VETRI			
Posizione	l	h	Q.tà
	L - 203	H - 253,5	1

Sezione B-B'

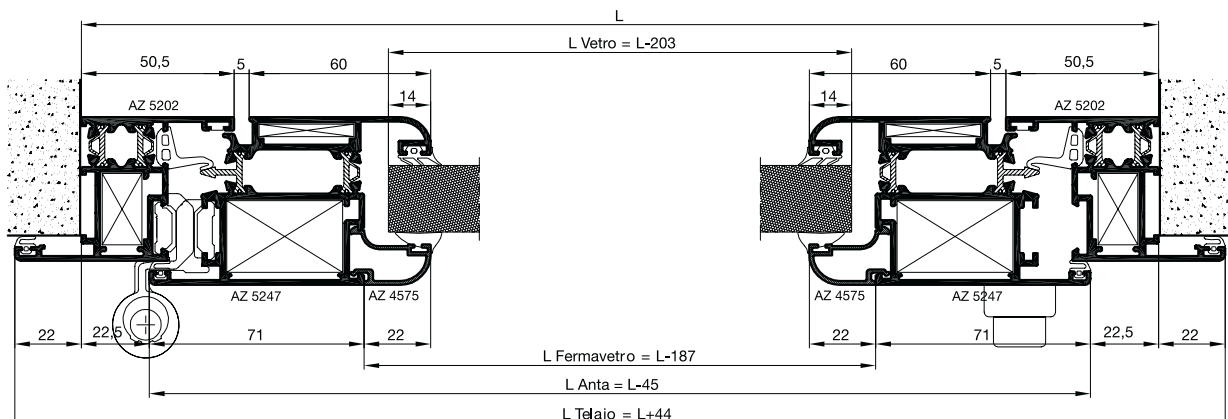

DISTINTA TAGLIO PROFILI

ARTICOLO	PROFILO	DESCRIZIONE	TAGLIO	Nr. Pezzi
AZ 5202		TELAIO Z	 H + 22	2
			 L + 44	1
AZ 5247		ANTA	 H - 28,5	2
			 L - 45	1
AZ 4575		FERMAVETRO	 H - 237,5	2
			 L - 187	2
AZ 5218		ZOCCOLO	 L - 177	1

GUARNIZIONI

	ART.	DESCRIZIONE	N° P.zzi
	Rg 308	G. INTERNA VETRO	2L + 2H
	Rg 312	G. ESTERNA VETRO	2L + 2H
	Rg 330	G. CENTRALE DI TENUTA	L + 2H
	Rg 402	G. BATTUTA INTERNA E A MURO	2L + 4H
	Ra 1703	ANGOLO VULCANIZZATO	2

ACCESSORI

ART.	DESCRIZIONE	N° P.zzi
Ra 1702	SQUADRETTA DI ALLINEAMENTO TELAIO	2
Ra 1705 Ra 1706	SQUADRETTA TELAIO INTERNA	2
Ra 1714	SQUADRETTA ANTA INTERNA	8
Ra 1713	SQUADRETTA ANTA ESTERNA	8
Ra 1404	REGOLATORE A MURO	8
Ra 1427	CERNIERA FLASH BASE	3
Ra 2327 Ra 2328	KIT DI TENUTA SOTTOZOCCOLO 1 o 2	L

PER GLI ACCESSORI DI CHIUSURA
CONSULTARE LE TABELLE SERRATURE

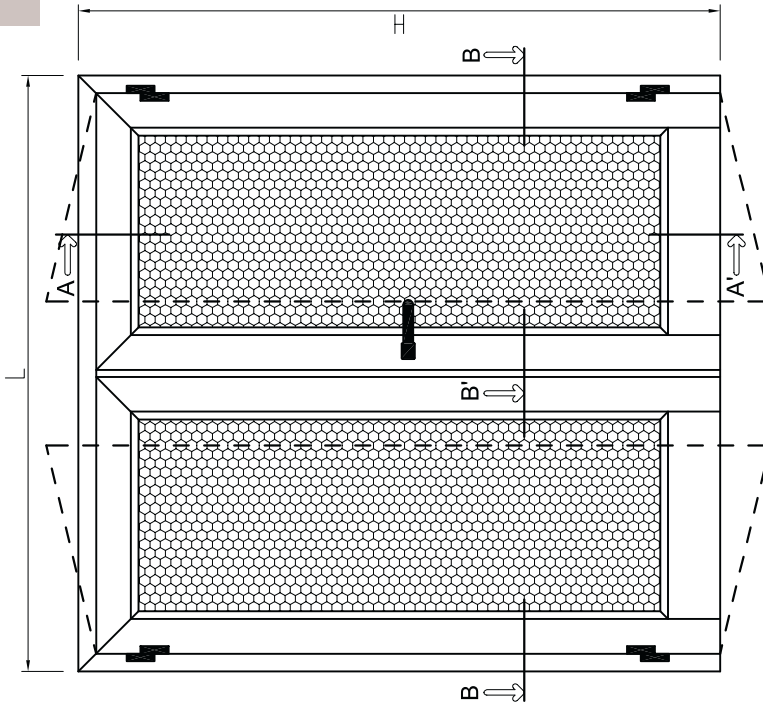

CALCOLO PESO PROFILI		TOTALE
Profili Orizz.	Kg/ml 6 x L	KG
Profili Vert.	Kg/ml 12,2 x H	
TOTALE		

DISTINTA TAGLIO VETRI			
Posizione	l	h	Q.tà
	L/2 - 183	H - 253,5	2

Sezione A-A'

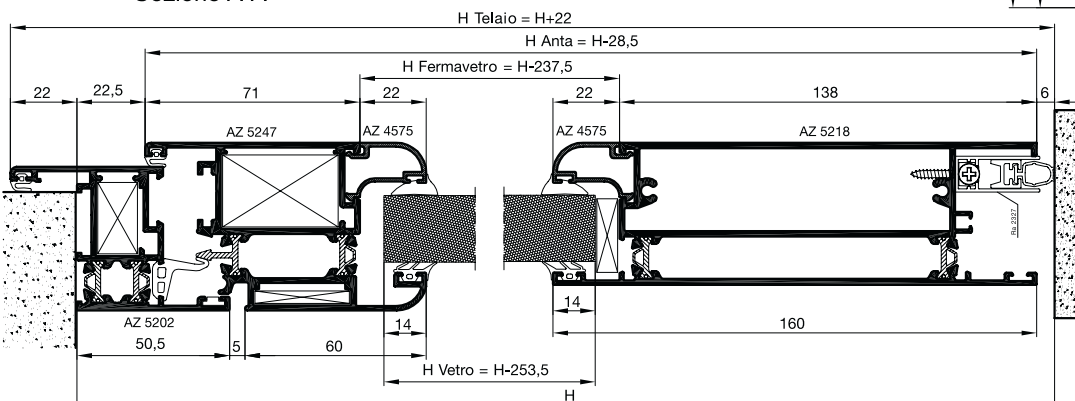

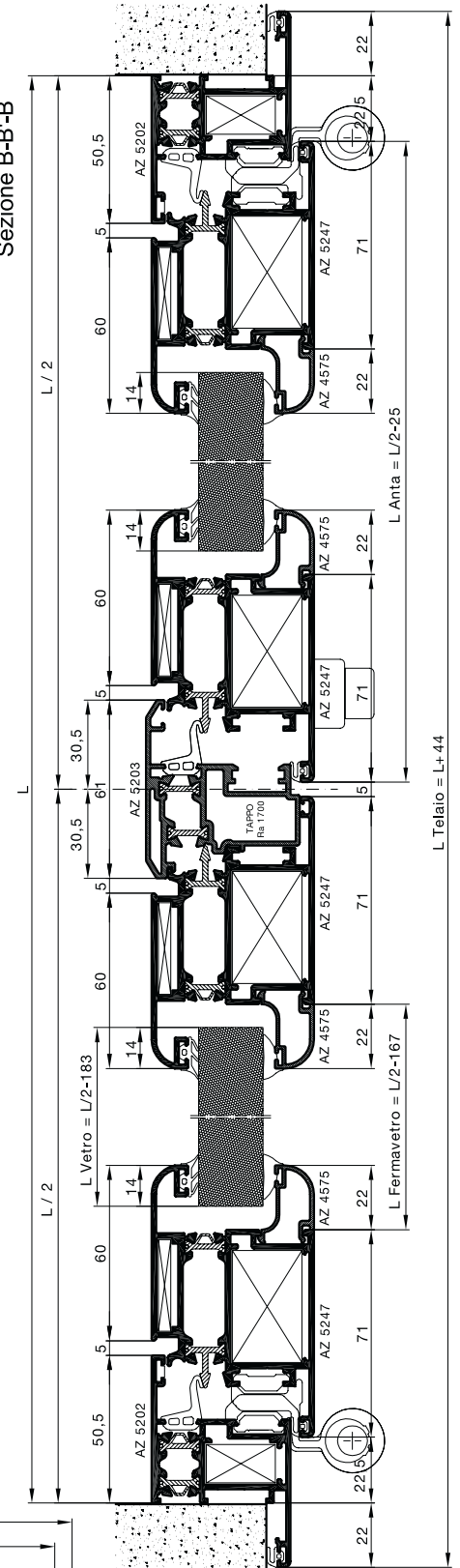

Sezione B-B'-B



DISTINTA TAGLIO PROFILI

ARTICOLO	PROFILO	DESCRIZIONE	TAGLIO	Nr. Pezzi
AZ 5202		TELAIO Z		2
				1
AZ 5247		ANTA		4
				2
AZ 5203		RIPORTO CENTRALE		1
AZ 4575		FERMAVETRO		4
				4
AZ 5218		ZOCCOLO		2

GUARNIZIONI

	ART.	DESCRIZIONE	N° P.zzi
	Rg 308	G. INTERNA VETRO	2L + 4H
	Rg 312	G. ESTERNA VETRO	2L + 4H
	Rg 330	G. CENTRALE DI TENUTA	L + 3H
	Rg 402	G. BATTUTA INTERNA E A MURO	2L + 5H
	Ra 1703	ANGOLO VULCANIZZATO	2

ACCESSORI

ART.	DESCRIZIONE	N° P.zzi
Ra 1702	SQUADRETTA DI ALLINEAMENTO TELAI0	2
Ra 1705 Ra 1706	SQUADRETTA TELAI0 INTERNA	2
Ra 1714	SQUADRETTA ANTA INTERNA	4
Ra 1713	SQUADRETTA ANTA ESTERNA	4
Ra 1404	REGOLATORE A MURO	10
Ra 1427	CERNIERA FLASH BASE	3
Ra 1700	TAPPO PER RIPORTO CENT.	1 CP.
Ra 2327 Ra 2328	KIT DI TENUTA SOTTOZOCCOLO 1 o 2	L

PER GLI ACCESSORI DI CHIUSURA
CONSULTARE LA TABELLA SERRATURE

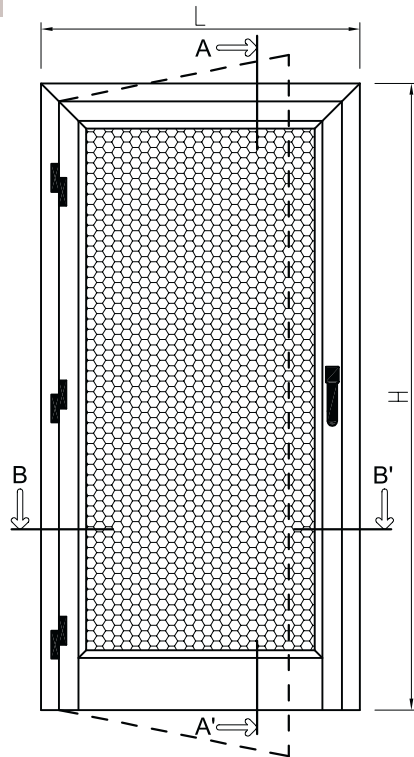

Sezione A-A'

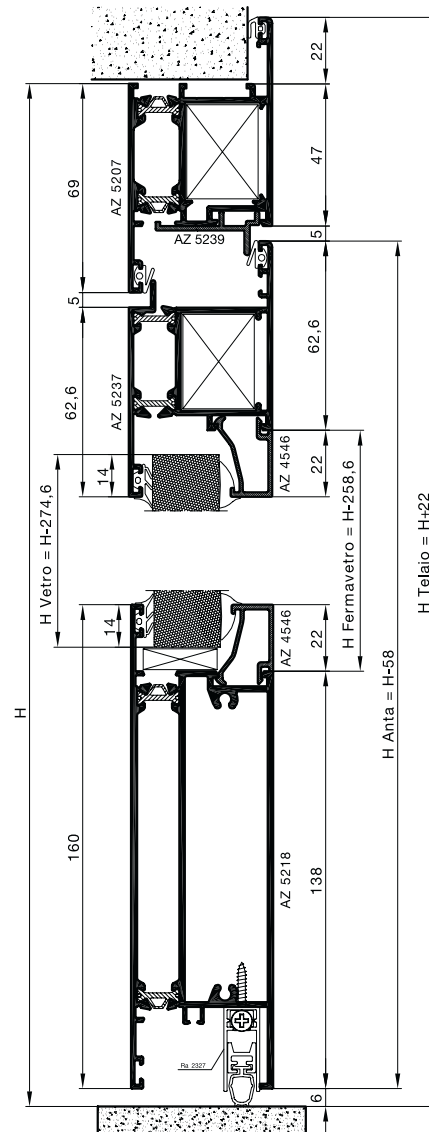





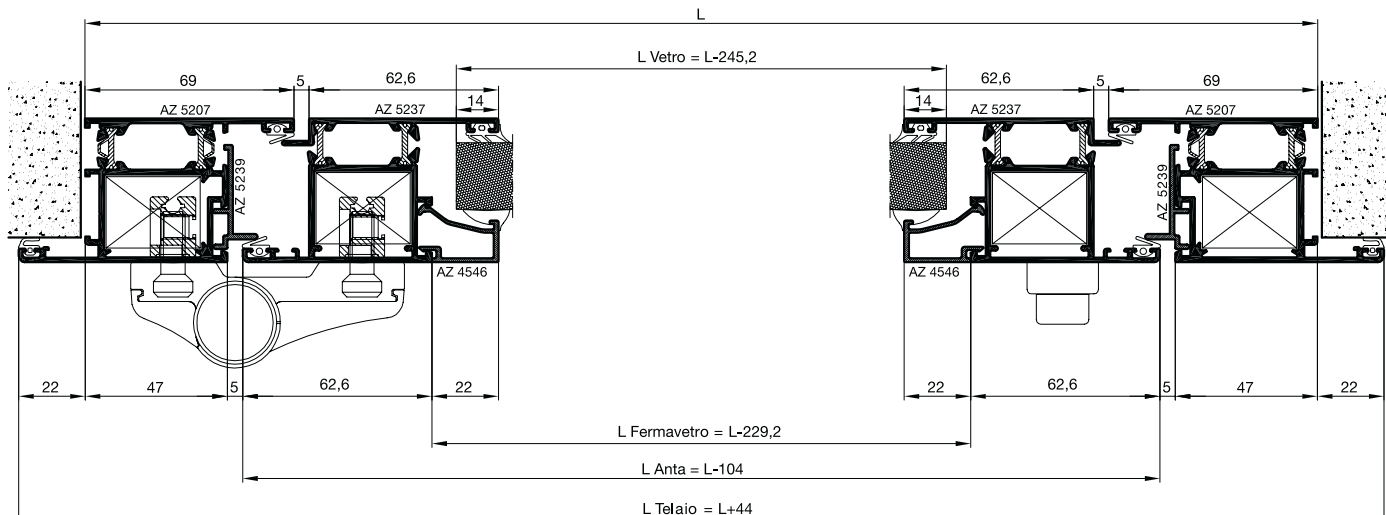

CALCOLO PESO PROFILI		TOTALE KG
Profili Orizz.	Kg/ml <u>6</u> x L _____	_____
Profili Vert.	Kg/ml <u>6,6</u> x H _____	_____
TOTALE		_____

DISTINTA TAGLIO VETRI			
Posizione	l	h	Q.tà
	L - 245,2	H - 274,6	1

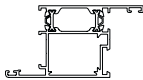
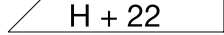
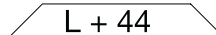
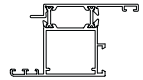
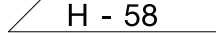
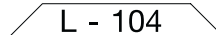

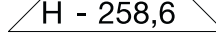
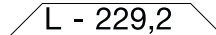

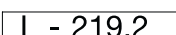
Sezione B-B'

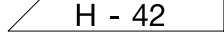
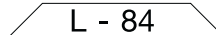

DISTINTA TAGLIO PROFILI

ARTICOLO	PROFILO	DESCRIZIONE	TAGLIO	Nr. Pezzi
AZ 5207		TELAIO Z	 H + 22	2
			 L + 44	1
AZ 5237		ANTA	 H - 58	2
			 L - 104	1
AZ 4546		FERMAVETRO	 H - 258,6	2
			 L - 229,2	2
AZ 5218		ZOCCOLO	 L - 219,2	1
AZ 5239		INVERSIONE DI BATTUTA	 H - 42	2
			 L - 84	1

GUARNIZIONI

	ART.	DESCRIZIONE	N° P.zzi
	Rg 308	G. INTERNA VETRO	2L + 2H
	Rg 312	G. ESTERNA VETRO	2L + 2H
	Rg 401	G. DI BATTUTA	2L + 4H
	Rg 402	G. BATTUTA A MURO	L + 2H

ACCESSORI

ART.	DESCRIZIONE	N° P.zzi
Ra 1707 Ra 1708	SQUADRETTA INTERNA PER TELAIO E ANTA	4
Ra 1404	REGOLATORE A MURO	8
Ra 1724 Ra 1725	CERNIERA A 2 ALI INT. 62,5 mm CERNIERA A 3 ALI INT. 62,5 mm	2
Ra 2327 Ra 2328	KIT DI TENUTA SOTTOZOCLOLO 1 o 2	L

PER GLI ACCESSORI DI CHIUSURA
CONSULTARE LA TABELLA SERRATURE

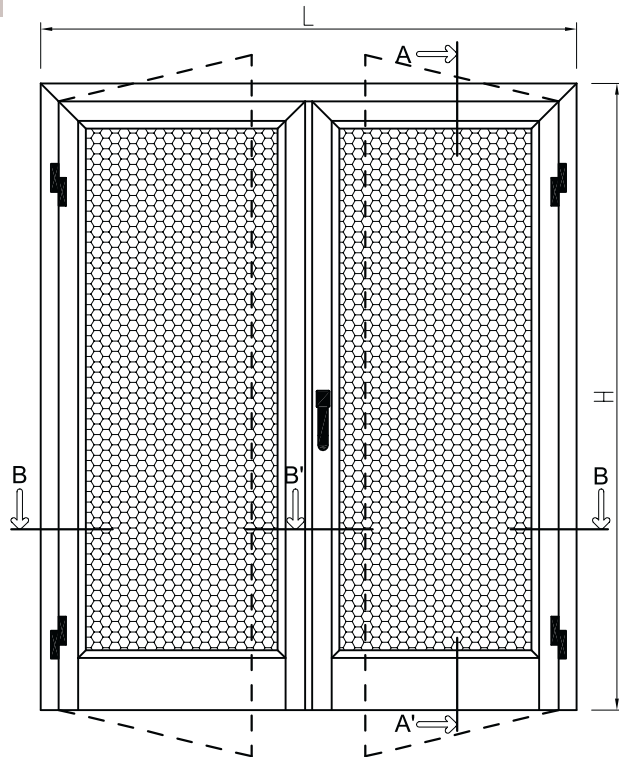

Sezione A-A'

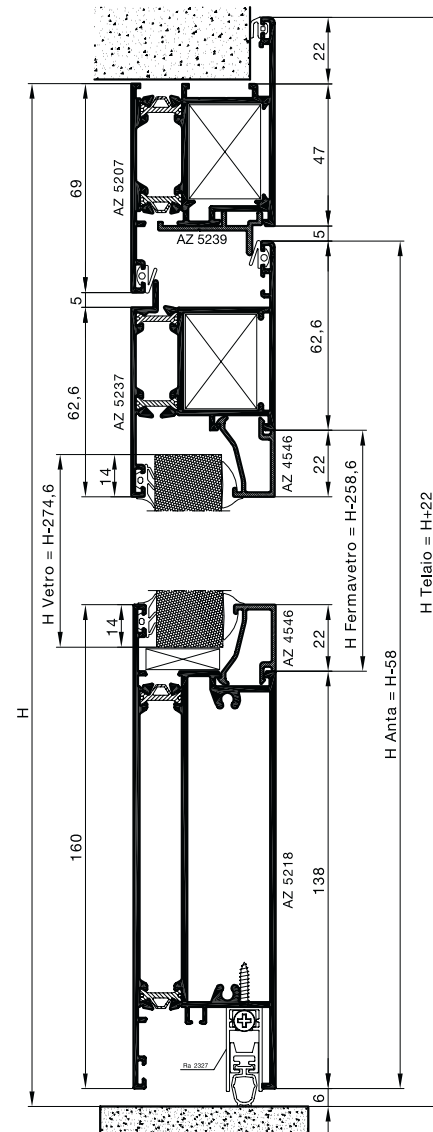



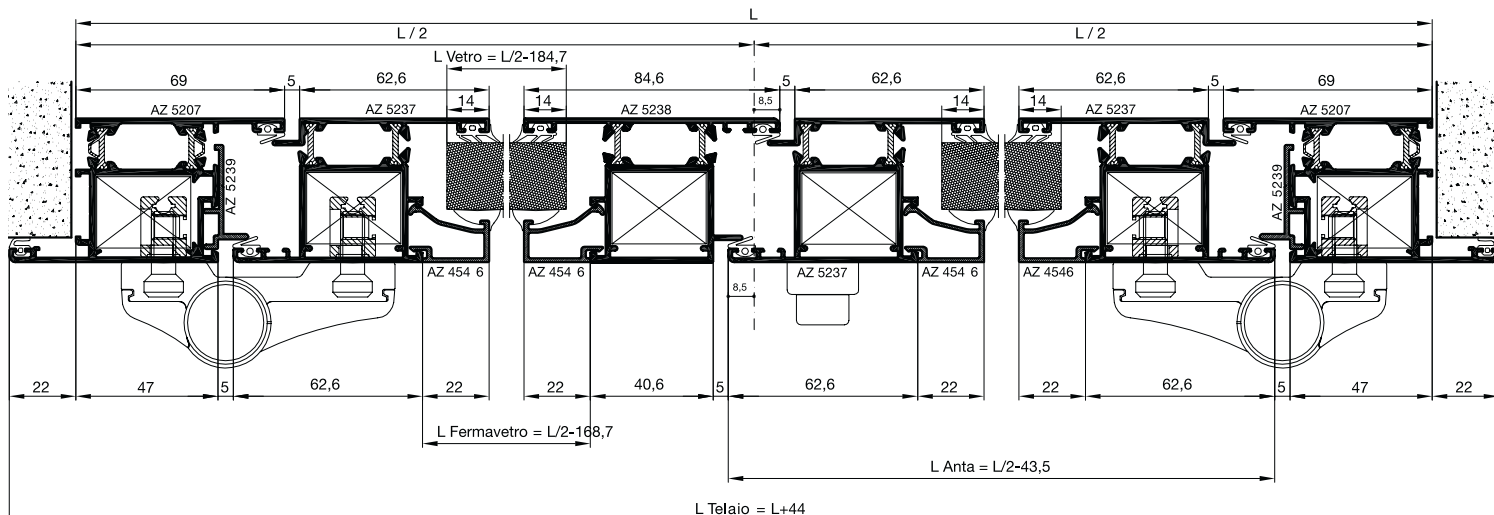

CALCOLO PESO PROFILI		TOTALE
	KG/ml	KG
Profili Orizz.	$\frac{6}{1000} \times L$	
Profili Vert.	$\frac{9,7}{1000} \times H$	
TOTALE		

DISTINTA TAGLIO VETRI			
Posizione	l	h	Q.tà
	L/2 - 184,7	H - 274,6	2



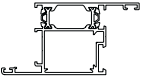
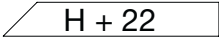
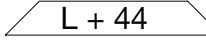
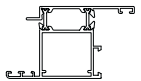
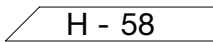
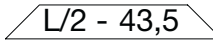
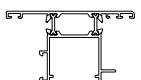
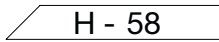

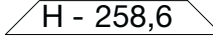
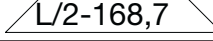
Sezione B-B'-B

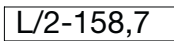
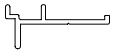
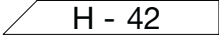
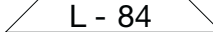

DISTINTA TAGLIO PROFILI

ARTICOLO	PROFILO	DESCRIZIONE	TAGLIO	Nr. Pezzi
AZ 5207		TELAIO Z		2
				1
AZ 5237		ANTA		3
				2
AZ 5238		MONTANTE ANTA INVERSIONE DI BATTUTA		1
AZ 4546		FERMAVETRO		4
				4
AZ 5218		ZOCCOLO		2
AZ 5239		INVERSIONE DI BATTUTA		2
				1

GUARNIZIONI

	ART.	DESCRIZIONE	N° P.zzi
	Rg 308	G. INTERNA VETRO	2L + 4H
	Rg 312	G. ESTERNA VETRO	2L + 4H
	Rg 401	G. DI BATTUTA	2L + 6H
	Rg 402	G. BATTUTA A MURO	L + 2H

ACCESSORI

ART.	DESCRIZIONE	N° P.zzi
Ra 1707 Ra 1708	SQUADRETTA INTERNA PER TELAIO E ANTA	6
Ra 1404	REGOLATORE A MURO	10
Ra 1724 Ra 1725	CERNIERA A 2 ALI INT. 62,5 mm CERNIERA A 3 ALI INT. 62,5 mm	4
Ra 1701	TAPPO DI FINITURA PORTE	1
Ra 2323	CATENACCIO TOTEM	2
Ra 2327 Ra 2328	KIT DI TENUTA SOTTOZOCOLO 1 o 2	L

PER GLI ACCESSORI DI CHIUSURA
CONSULTARE LA TABELLA SERRATURE

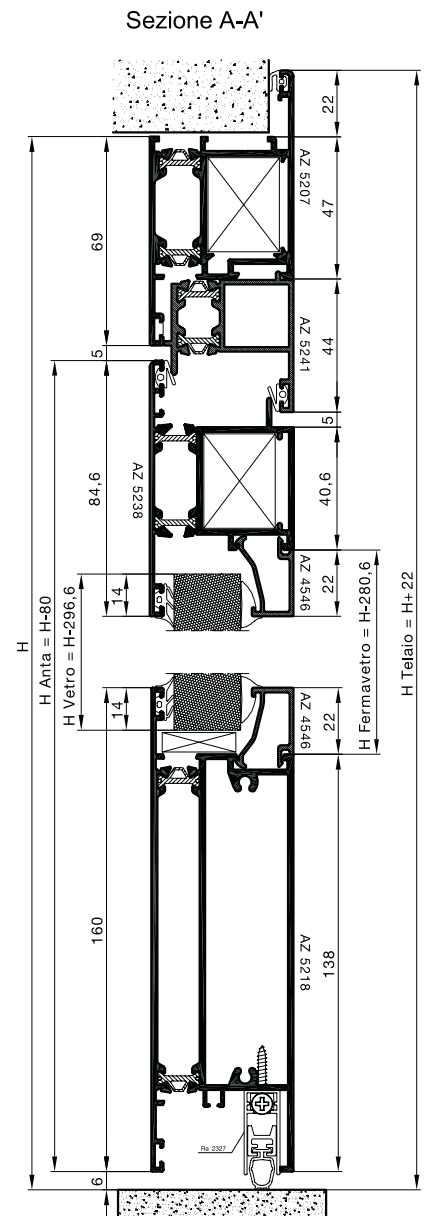
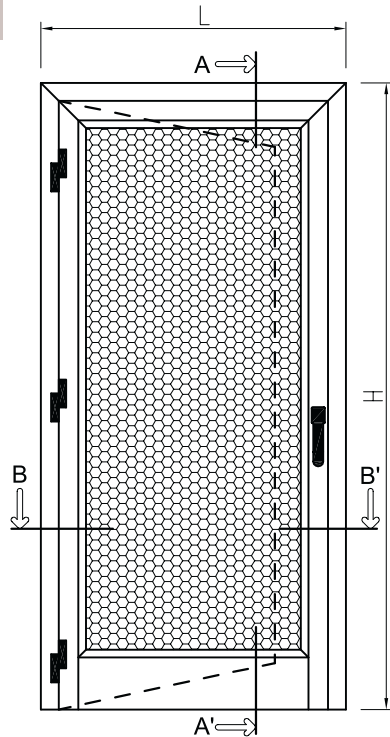



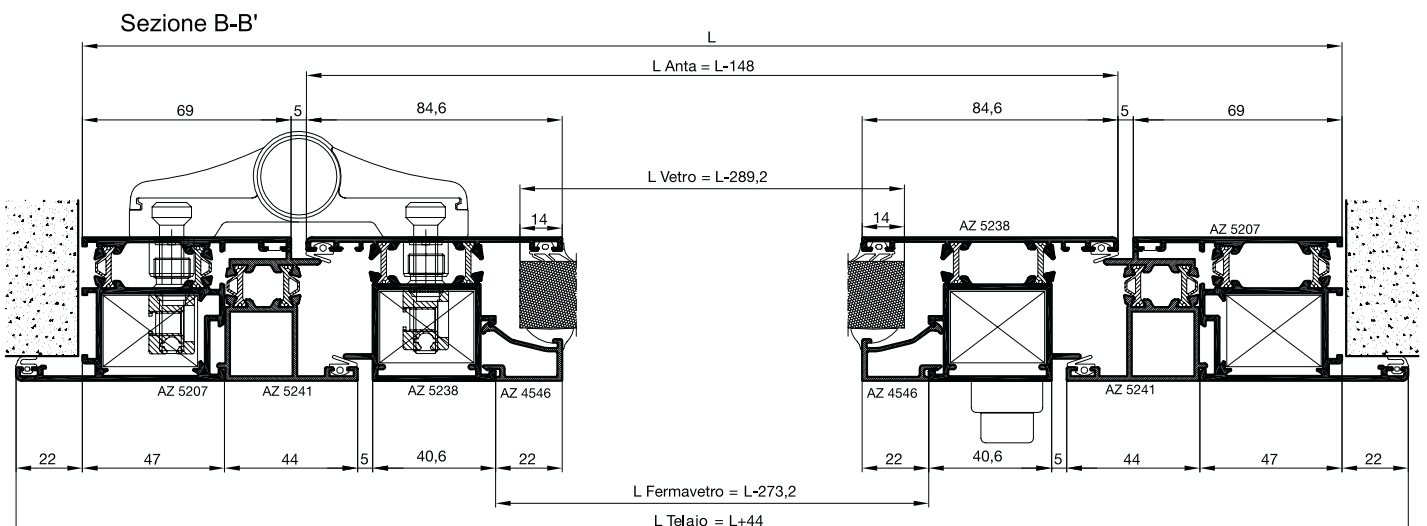

CALCOLO PESO PROFILI		TOTALE KG
Profili Orizz.	Kg/ml $6,7 \times L$	
Profili Vert.	Kg/ml $7,9 \times H$	
TOTALE		

DISTINTA TAGLIO VETRI			
Posizione	l	h	Q.tà
	L - 289,2	H - 296,6	1

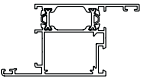
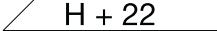
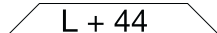
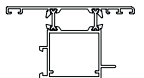
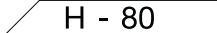
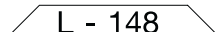

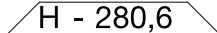
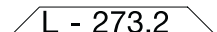
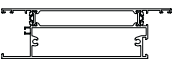
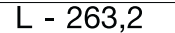
DISTINTA TAGLIO PROFILI

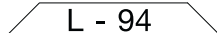
ARTICOLO	PROFILO	DESCRIZIONE	TAGLIO	Nr. Pezzi
AZ 5207		TELAIO Z	 H + 22	2
			 L + 44	1
AZ 5238		ANTA	 H - 80	2
			 L - 148	1
AZ 4546		FERMAVETRO	 H - 280,6	2
			 L - 273,2	2
AZ 5218		ZOCCOLO	 L - 263,2	2
AZ 5241		INVERSIONE DI BATTUTA	 H - 47	2
			 L - 94	1

GUARNIZIONI

	ART.	DESCRIZIONE	N° P.zzi
	Rg 308	G. INTERNA VETRO	2L + 2H
	Rg 312	G. ESTERNA VETRO	2L + 2H
	Rg 401	G. DI BATTUTA	2L + 4H
	Rg 402	G. BATTUTA A MURO	L + 2H

ACCESSORI

ART.	DESCRIZIONE	N° P.zzi
Ra 1707 Ra 1708	SQUADRETTA INTERNA PER TELAIO E ANTA	4
Ra 1404	REGOLATORE A MURO	8
Ra 1726 Ra 1727	CERNIERA A 2 ALI INT. 84 mm CERNIERA A 3 ALI INT. 84 mm	2
Ra 2318	BOCCOLE TELESCOPICHE	4
Ra 2327 Ra 2328	KIT DI TENUTA SOTTOZOCCOLO 1 o 2	L

PER GLI ACCESSORI DI CHIUSURA
CONSULTARE LA TABELLA SERRATURE

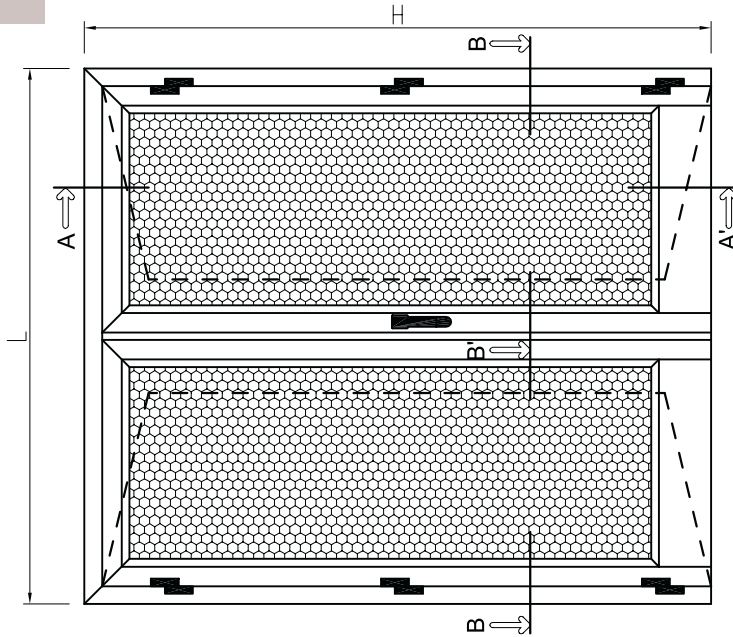

CALCOLO PESO PROFILI		TOTALE KG
Profili Orizz.	Kg/ml <u>6,7</u> x L	
Profili Vert.	Kg/ml <u>11</u> x H	
TOTALE		

DISTINTA TAGLIO VETRI			
Posizione	l	h	Q.tà
	L/2 - 206,7	H - 296,6	2



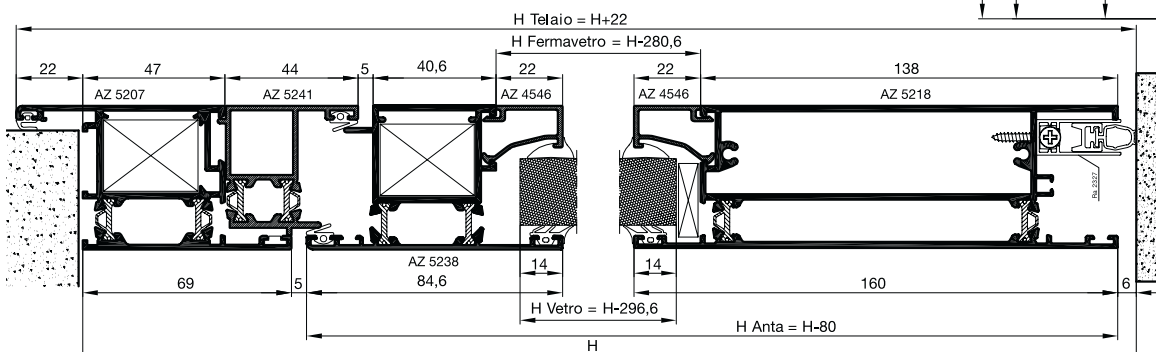

Sezione A-A'

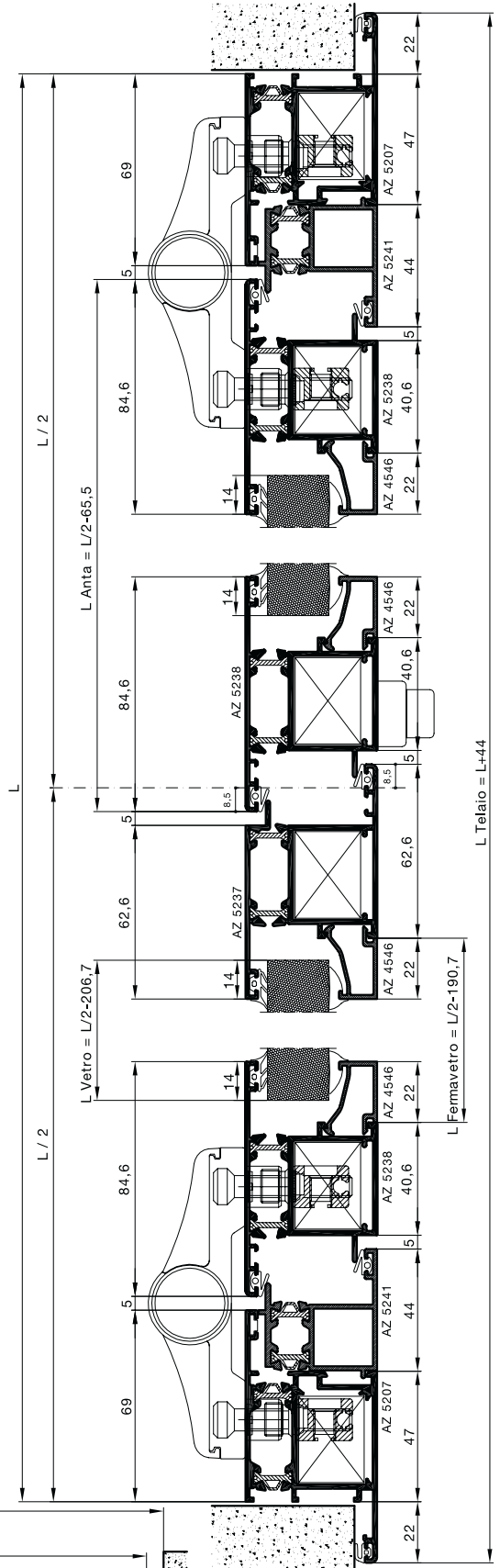



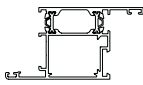
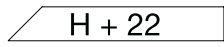
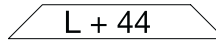
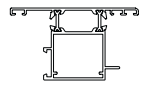
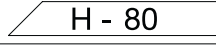
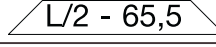
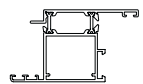
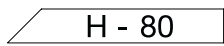

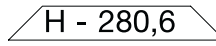
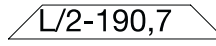
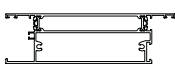
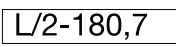
Sezione B-B'-B

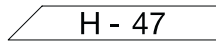
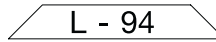

DISTINTA TAGLIO PROFILI

ARTICOLO	PROFILO	DESCRIZIONE	TAGLIO	Nr. Pezzi
AZ 5207		TELAIO Z		2
				1
AZ 5238		ANTA		3
				2
AZ 5237		MONTANTE ANTA INVERSIONE DI BATTUTA		1
AZ 4546		FERMAVETRO		4
				4
AZ 5218		ZOCCOLO		2
AZ 5241		INVERSIONE DI BATTUTA		2
				1

GUARNIZIONI

	ART.	DESCRIZIONE	N° P.zzi
	Rg 308	G. INTERNA VETRO	2L + 4H
	Rg 312	G. ESTERNA VETRO	2L + 4H
	Rg 401	G. DI BATTUTA	2L + 6H
	Rg 402	G. BATTUTA A MURO	L + 2H

ACCESSORI

ART.	DESCRIZIONE	N° P.zzi
Ra 1707 Ra 1708	SQUADRETTA INTERNA PER TELAIO E ANTA	6
Ra 1404	REGOLATORE A MURO	10
Ra 1726 Ra 1727	CERNIERA A 2 ALI INT. 84 mm CERNIERA A 3 ALI INT. 84 mm	4
Ra 2318	BOCCOLE TELESCOPICHE	8
Ra 1701	TAPPO DI FINITURA PORTE	1
Ra 2323	CATENACCIO TOTEM	2
Ra 2327 Ra 2328	KIT DI TENUTA SOTTOZOCCOLO 1 o 2	L

PER GLI ACCESSORI DI CHIUSURA
CONSULTARE LA TABELLA SERRATURE

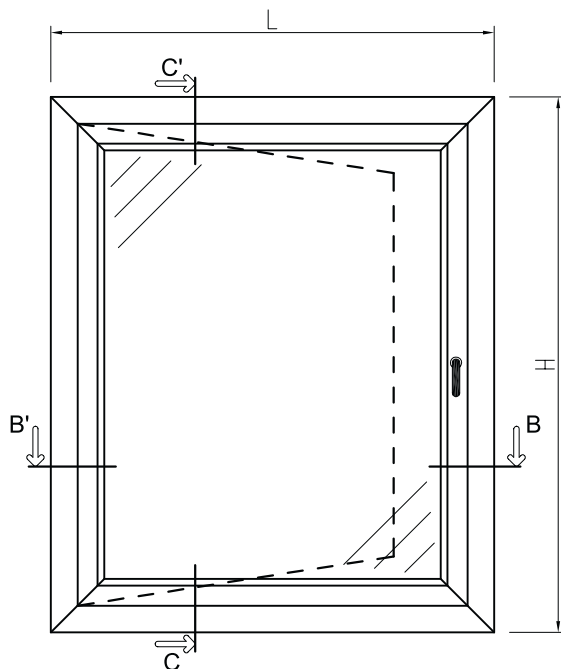

Sezione C-C'

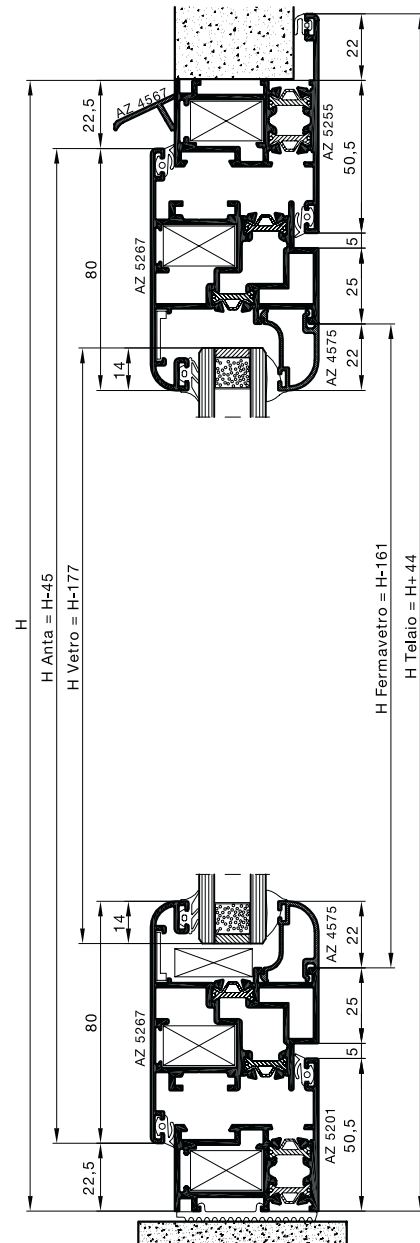







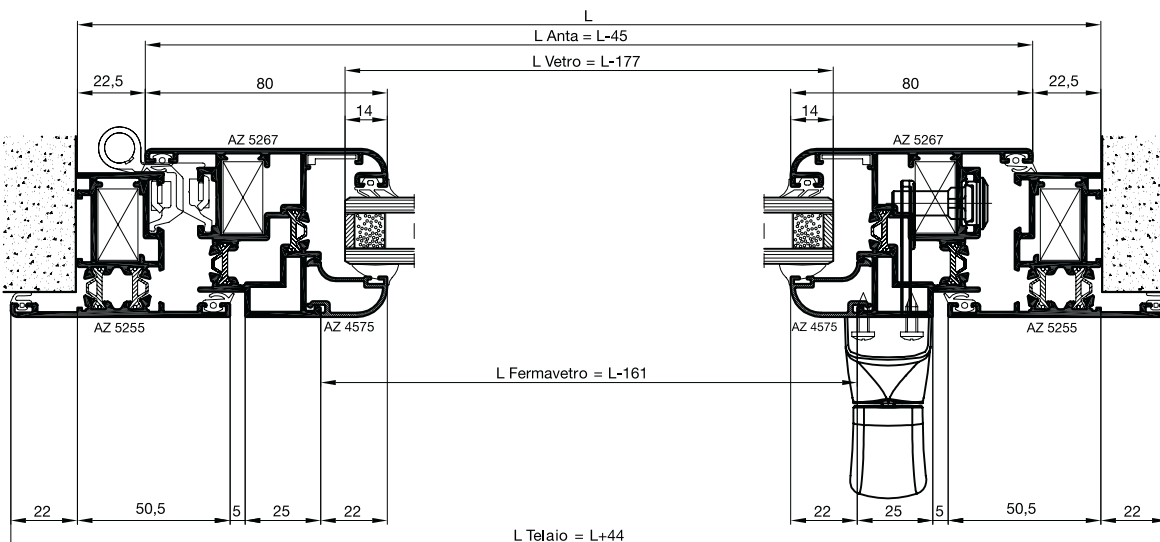

CALCOLO PESO PROFILI		TOTALE KG
Profili Orizz.	Kg/ml $6,3 \times L$	
Profili Vert.	Kg/ml $6,5 \times H$	
TOTALE		

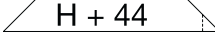
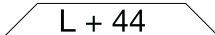
DISTINTA TAGLIO VETRI			
Posizione	l	h	Q.tà
	L - 177	H - 177	1

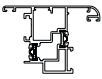
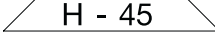
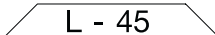
Sezione B-B'

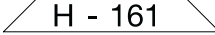
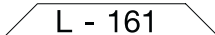

DISTINTA TAGLIO PROFILI

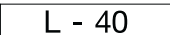
ARTICOLO	PROFILO	DESCRIZIONE	TAGLIO	Nr. Pezzi
AZ 5255		TELAIO T	 H + 44	2
			 L + 44	1
AZ 5201		TELAIO L	 L	1
AZ 5267		ANTA	 H - 45	2
			 L - 45	2
AZ 4575		FERMAVETRO	 H - 161	2
			 L - 161	2
AZ 2035		ASTINA DI COMANDO		1
AZ 4567		GOCCIOLATOIO	 L - 40	1

GUARNIZIONI

	ART.	DESCRIZIONE	N° P.zzi
	Rg 308	G. INTERNA VETRO	2L + 2H
	Rg 312	G. ESTERNA VETRO	2L + 2H
	Rg 303	G. DI BATTUTA	4L + 4H
	Rg 402	G. BATTUTA A MURO	L + 2H
	Rg 323	G. ISOLAMENTO SOGLIA	1L

ACCESSORI

ART.	DESCRIZIONE	N° P.zzi
Ra 1705 Ra 1706	SQUADRETTA INTERNA PER TELAIIO E ANTA	8
Ra 1704	SQUADRETTA ALLINEAMENTO ANTA	4
Ra 1404	REGOLATORE A MURO	8
Ra 2601	BOCCOLA SCARICO ACQUA	2
Ra 1427	CERNIERA FLASH BASE	2
Ra 1031	CREMONESE UNICA	1
Ra 1731	KIT PER APERTURA ESTERNA	1
Ra 1732	TRAINO ASTINA	2
Ra 1453	RINVIO AD ANGOLO	2
Ra 2918	NOTTOLINO REGISTRABILE	4
Ra 2907	INCONTRO DI CHIUSURA PER Ra 2918	4

Sezione C-C'

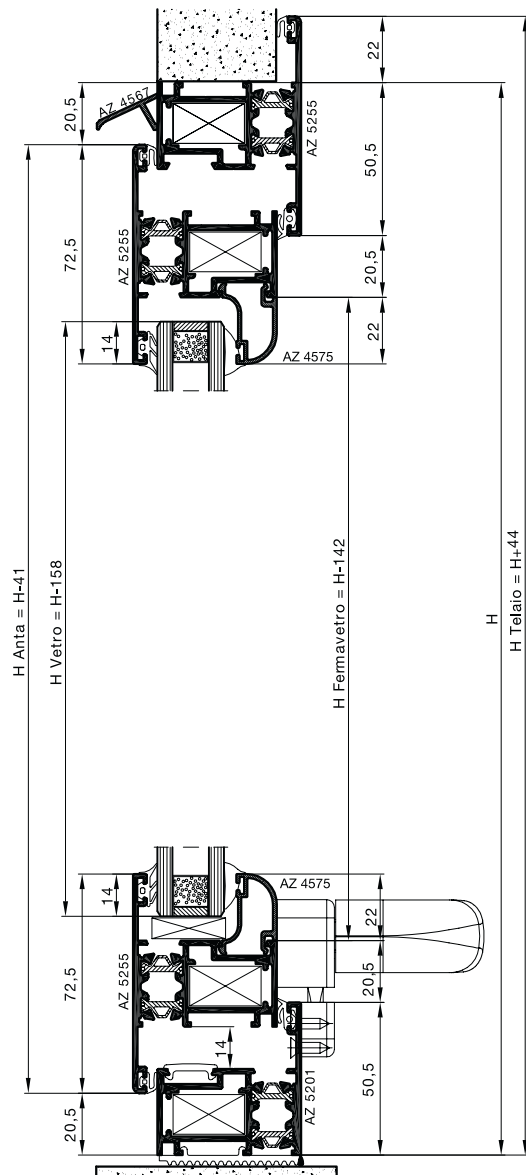
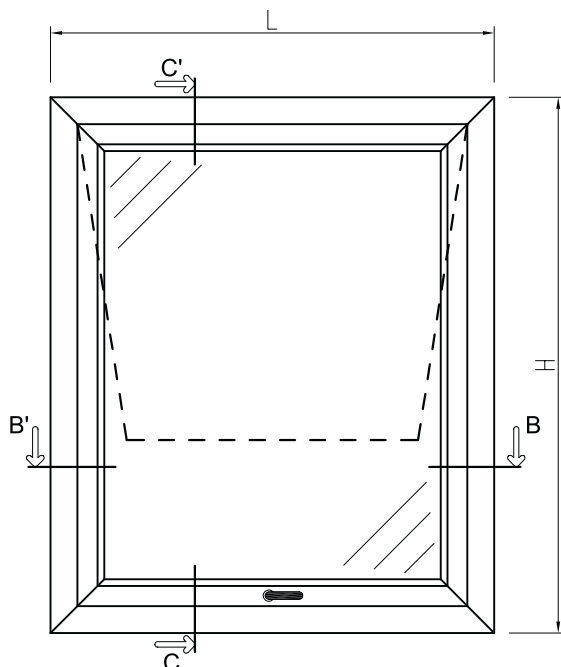







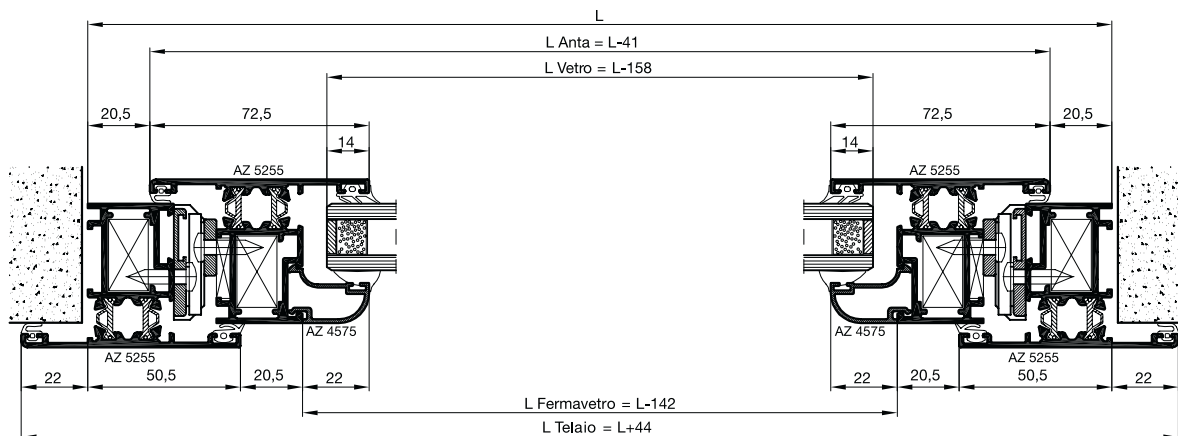

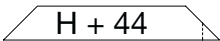
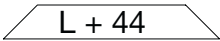

CALCOLO PESO PROFILI		TOTALE KG
Profili Orizz.	Kg/ml <u>5,8</u> x L	
Profili Vert.	Kg/ml <u>5,9</u> x H	
TOTALE		

DISTINTA TAGLIO VETRI			
Posizione	l	h	Q.tà
	L - 158	H - 158	1

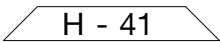
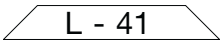

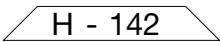
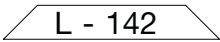

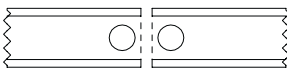
Sezione B-B'

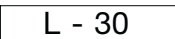

DISTINTA TAGLIO PROFILI

ARTICOLO	PROFILO	DESCRIZIONE	TAGLIO	Nr. Pezzi
AZ 5255		TELAIO T	 H + 44	2
			 L + 44	1
AZ 5201		TELAIO L	 L	1
AZ 5255		ANTA	 H - 41	2
			 L - 41	2
AZ 4575		FERMAVETRO	 H - 142	2
			 L - 142	2
AZ 2035		ASTINA DI COMANDO		1
AZ 4567		GOCCIOLATOIO	 L - 30	1

GUARNIZIONI

	ART.	DESCRIZIONE	N° P.zzi
	Rg 308	G. INTERNA VETRO	2L + 2H
	Rg 312	G. ESTERNA VETRO	2L + 2H
	Rg 303	G. DI BATTUTA INTERNA	2L + 2H
	Rg 402	G. BATTUTA INTERNA E A MURO	3L + 4H
	Rg 323	G. ISOLAMENTO SOGLIA	1L

ACCESSORI

ART.	DESCRIZIONE	N° P.zzi
Ra 1705 Ra 1706	SQUADRETTA INTERNA PER TELAIO E ANTA	8
Ra 1404	REGOLATORE A MURO	10
Ra 2601	BOCCOLA SCARICO ACQUA	2
Ra 1729	BRACCIO PER SPORGERE	1
Ra 1730	MANIGLIA A TAVELLINO	1

FINESTRA A BILICO
- anta con fermavetro -

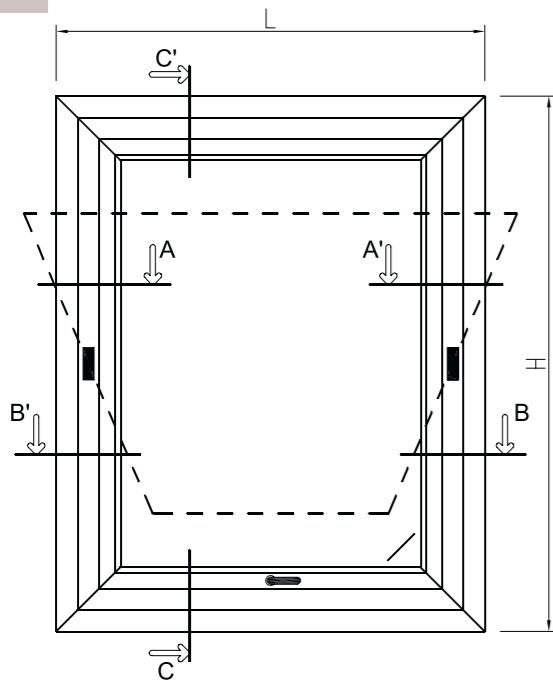

CALCOLO PESO PROFILI		TOTALE KG
Profili Orizz.	Kg/ml 8,2 x L	
Profili Vert.	Kg/ml 8,3 x H	
TOTALE		

DISTINTA TAGLIO VETRI			
Posizione	l	h	Q.tà
	L - 278	H - 278	1

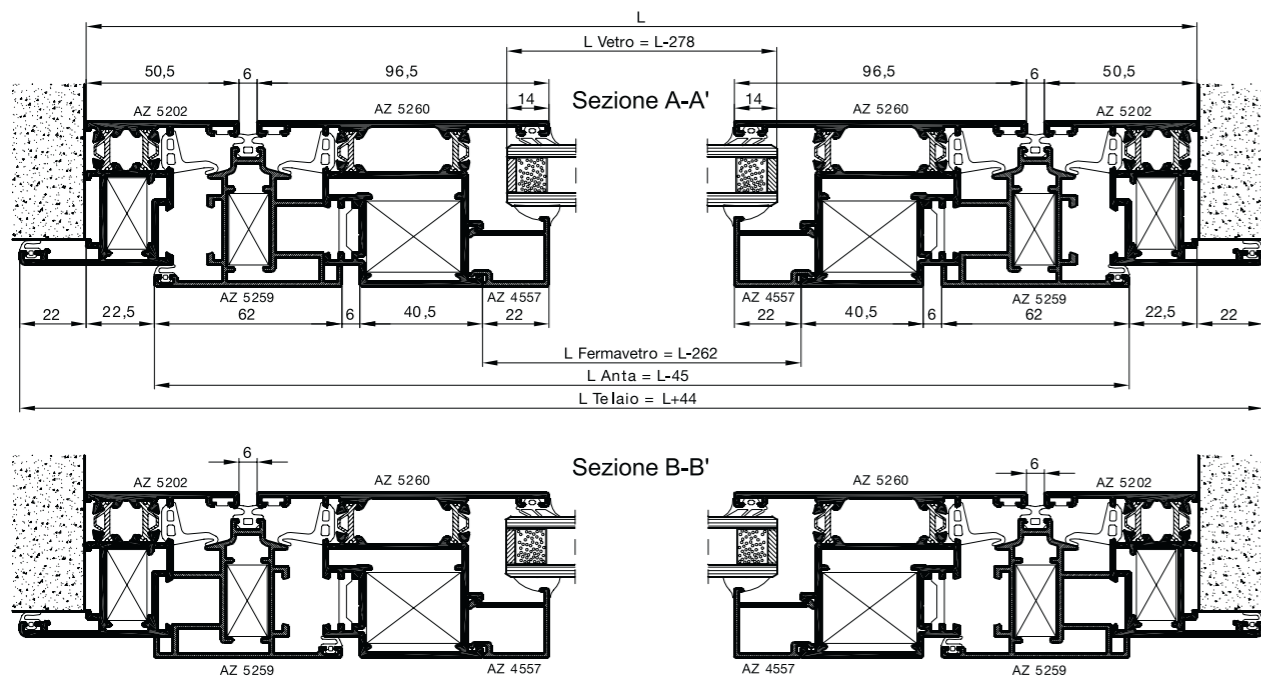
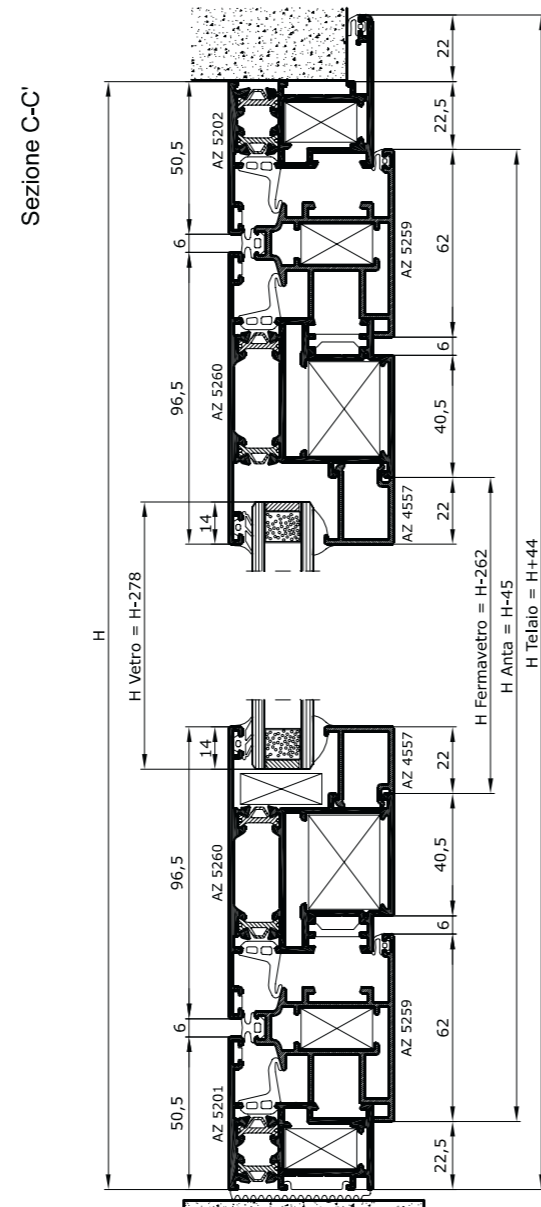

DISTINTA TAGLIO PROFILI				
ARTICOLO	PROFILO	DESCRIZIONE	TAGLIO	Nr. Pezzi
AZ 5202		TELAIOZ		2
				1
AZ 5201		TELAIO L		1
AZ 5260		ANTA		2
				2
AZ 5259		INVERSIONE DI BATTUTA		2
				2
AZ 4557		FERMAVETRO		2
				2
AZ 2035		ASTINA DI COMANDO		1

GUARNIZIONI			
	ART.	DESCRIZIONE	N° P.zzi
	Rg 308	G. INTERNA VETRO	2L + 2H
	Rg 312	G. ESTERNA VETRO	2L + 2H
	Rg 356	G. PERIMETRALE BILICO	2L + 2H
	Rg 330	G. CENTRALE DI TENUTA	4L + 4H
	Rg 402	G. BATTUTA INTERNA E A MURO	3L + 4H
	Ra 1703	ANGOLO VULCANIZZATO	4
	Rg 323	G. ISOLAMENTO SOGLIA	1L

ACCESSORI		
ART.	DESCRIZIONE	N° P.zzi
Ra 1702	SQUADRETTA DI ALLINEAMENTO TELAIO	4
Ra 1705	SQUADRETTA INTERNA TELAIO E INVERSIONE DI BATTUTA	8
Ra 1706		
Ra 1707	SQUADRETTA ANTA INTERNA	4
Ra 1708		
Ra 1702	SQUADRETTA DI ALLINEAMENTO ANTA	4
Ra 1404	REGOLATORE A MURO	8
Ra 1033	CAPPETTA DI DRENAGGIO	2

ACCESSORI BILICO		
ART.	DESCRIZIONE	N° P.zzi
Ra 1736	FRIZIONE	1cp.
Ra 1434	COMANDO INTERNO BIDIREZIONALE	1
Ra 2916	MARTELLINA PRIMA	1
Ra 2918	NOTTOLINO DI CHIUSURA	4
Ra 2907	INCONTRO DI CHIUSURA	4
Ra 1453	RINVIO D'ANGOLO	2
Ra 1446	PERNI DI COLLEGAMENTO	6

In alternativa alla chiusura con martellina è possibile utilizzare la maniglia tavellino Ra 1439

GUARNIZIONI

ART.	DESCRIZIONE	N° P.zzi
Rg 308	G. INTERNA VETRO	2L + 4H
Rg 312	G. ESTERNA VETRO	2L + 4H
Rg 330	G. CENTRALE DI TENUTA	2L + 3H
Rg 402	G. BATTUTA INTERNA	2L + 3H
48x1200	G. A SPAZZOLINO mm5x11	L
48x900	G. A SPAZZOLINO mm5x11	4H
Ra 1703	ANGOLO VULCANIZZATO	4
Rg 323	G. ISOLAMENTO SOGLIA	L

ACCESSORI PER MONOBLOCCO

ART.	DESCRIZIONE	N° P.zzi
Ra 1036	PASSACINTINO	1
Ra 1058	TAPPO RACCOGLI CONDENSA	1CP.
Ra 1073	TAPPI CASSONETTO UNIPROFIL	1CP.
Ra 1419	INVITI PER GUIDA	1CP.
Ra 1476	KIT DI MOVIMENTAZIONE PER TAPPARELLA TIPO SIMBAC	1

N.B.=IL KIT DI MOVIMENTAZIONE COMPRENDE
-1 AVVOLGITORE
-1 PULEGGIA
-1 CALOTTA
-2 SUPPORTI CON CUSCINETTO

DISTINTA TAGLIO PROFILI

ARTICOLO	PROFILO	DESCRIZIONE	TAGLIO	Nr. Pezzi
AZ 5236		TRAVERSO SUPERIORE	L - 182	1
AZ 5235		SPALLA MONOBLOCCO	H	2
AZ 5264		TRAVERSO INFERIORE	L - 182	1
AZ 5217		ANTA	H - 44	4
			L/2 - 92,5	4
AZ 5203		RIPORTO CENTRALE	H - 110	1
AZ 4569		CASSONETTO CENTRALE	H - 7	1
AZ 4568		CASSONETTO INF. e SUP.	H - 7	2
TO 4008		ANGOLARE DI SOSTEGNO	H	1
AZ 4567		GOCCIOLATOIO	L/2 - 158,5	2
AZ 2047		COPRIFILO MONOBLOCCO	H	2
AZ 2035		ASTINA DI COMANDO		1

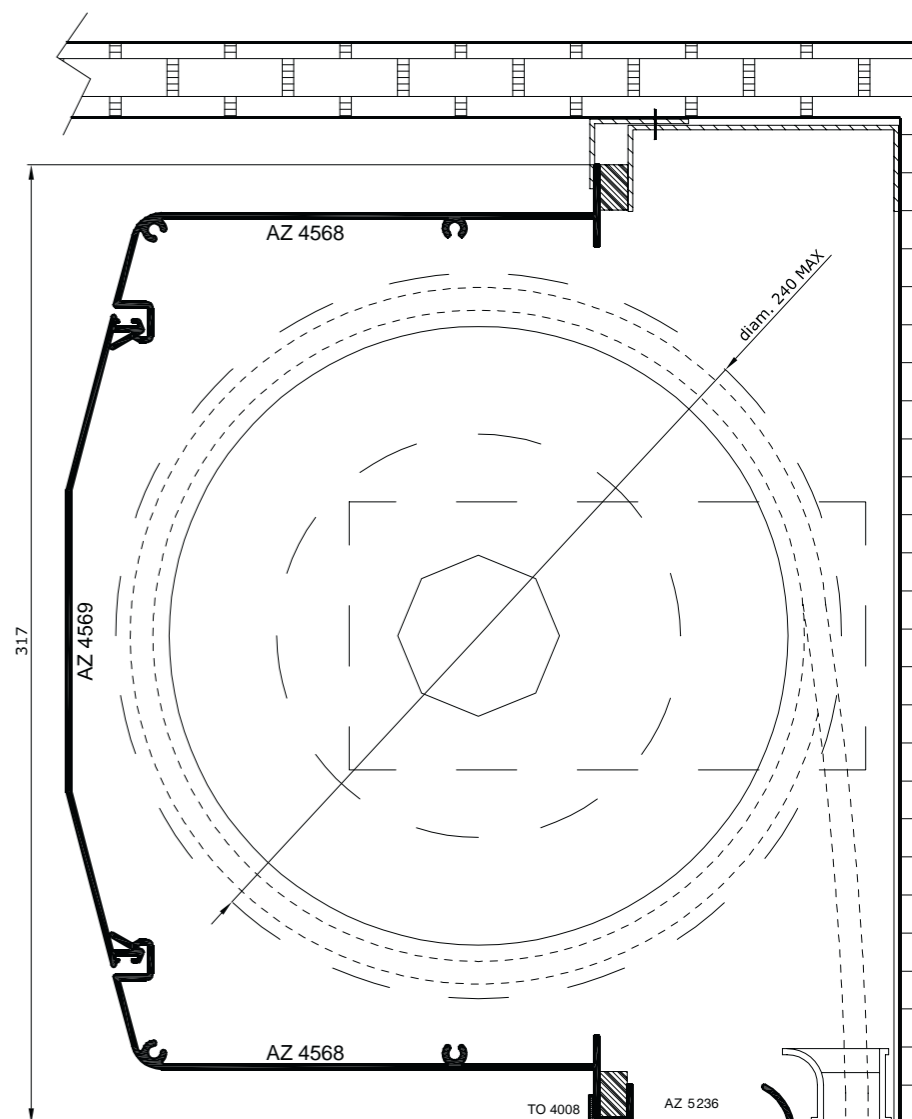

DISTINTA TAGLIO VETRI

Posizione	l	h	Q.tà
	L/2 - 200,5	H - 152	2

CALCOLO PESO PROFILI		TOTALE KG
Profili Orizz.	Kg/ml 9,5 x L	
Profili Vert.	Kg/ml 12 x H	
TOTALE		

ACCESSORI ANTA BATTENTE

ART.	DESCRIZIONE	N° P.zzi
Ra 1427	CERNIERA FLASH BASE	4
Ra 1056	CREMONESE PRIMA	1
Ra 1447	BLOCCHETTO DI COLLEGAMENTO	1CP.
Ra 1002	TERMINALE DI CHIUSURA	2
Ra 2808	INCONTRO DOPPIO IN ZAMA	2
Ra 1035	CATENACCI GIAP IN NYLON	2
Ra 1700	TAPPO PER RISCONTRO CENTR.	1CP.
Ra 1710	SQUADRETTA ANTA ESTERNA	8
Ra 1705 Ra 1706	SQUADRETTA ANTA	8
Ra 1033	CAPPETTA DI DRENAGGIO	3
Ra 1420	CAVALLOTTI	2

